

65th Anniversary Production Sale

Wednesday April 14th, 2010

Industry Leaders for Low
Maintenance, Maternal Traits

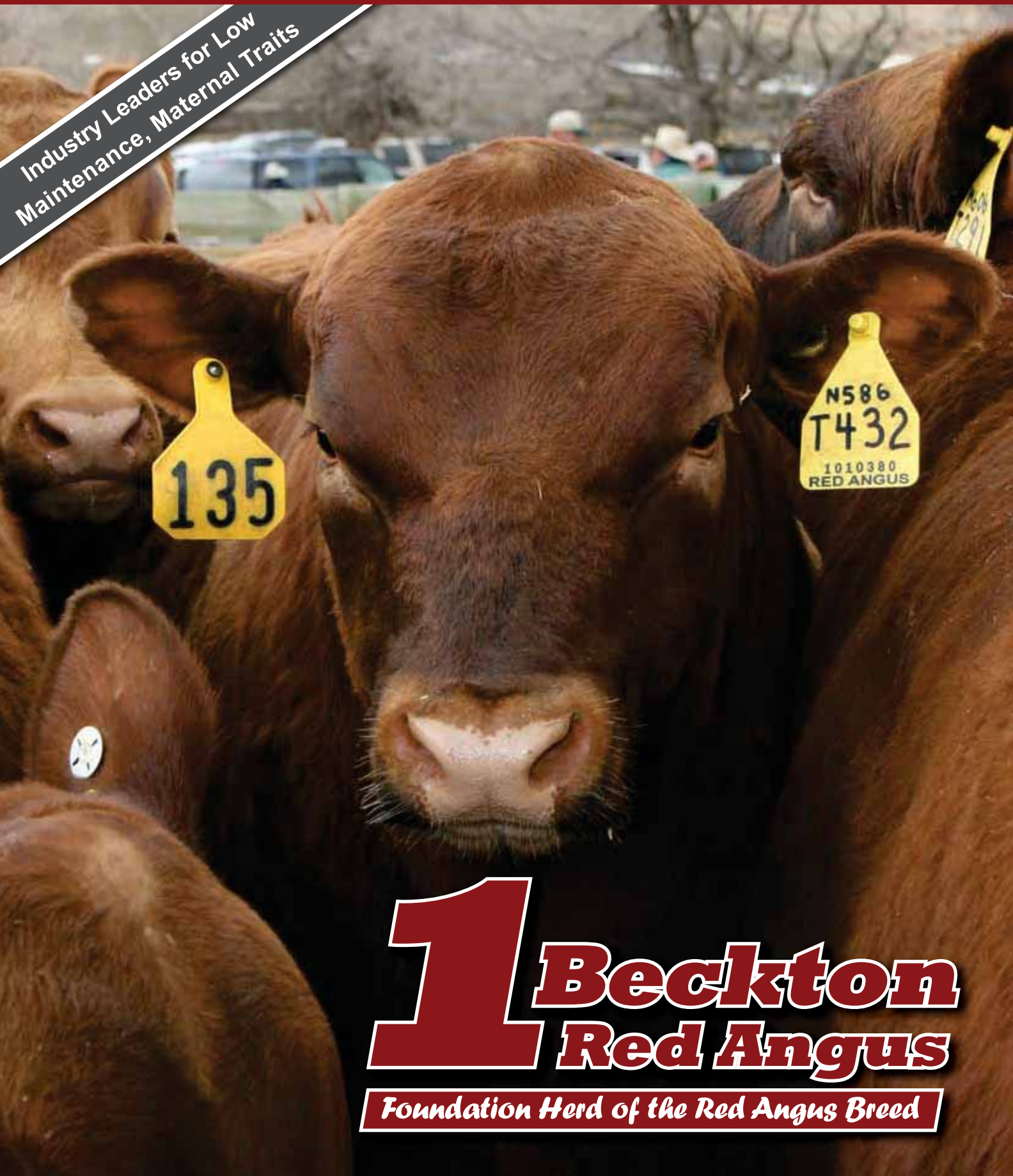

1 Beckton Red Angus

Foundation Herd of the Red Angus Breed

Transportation

Great Lakes Airlines

Several daily flights to/from Denver
Contact Holiday Inn for airport transfers

Avis Car Rental

T: 307.672.2226, Sheridan Airport

Accommodations

Holiday Inn

307.672.8931, I-90, Exit 25
Beckton Sale Rate: \$85

Best Western Sheridan Center

307.674.7421, 612 N. Main Street
Beckton Sale Rate: \$89

Days Inn

307.672.2888, 1104 Brundage Lane

Super 8 Motel

307.672.9725, 2435 N. Main Street



Auctioneer Roger Jacobs
406.698.7686

Sight-Unseen Purchase (by mail or phone)

If you are unable to attend the sale, we can help you select the bulls or females to fit your needs. Give us a phone call, letter, fax or e-mail (please refer to the the back cover), and we can make arrangements to handle bidding according to your directions. Bulls are bought at the lowest price, and satisfaction is guaranteed on bulls purchased sight unseen. Many of our repeat customers buy their bulls this way.

To provide us adequate time to assist you, please contact us before noon of the day prior to the sale.

Free Delivery

We pay for delivery for all bulls and registered heifers throughout the Continental U.S. If you do bring a trailer to haul your own, \$50 will be deducted from the price of each bull or registered heifer. Most of the sale cattle will be delivered from 1-3 weeks after the sale, although we will try to accommodate special needs. Although there occasionally are limitations, in most cases we can deliver the cattle directly to your ranch.

Payment

Payments can be made with cash, check payable to Beckton Stock Farm, or Visa/Mastercard on sale day.

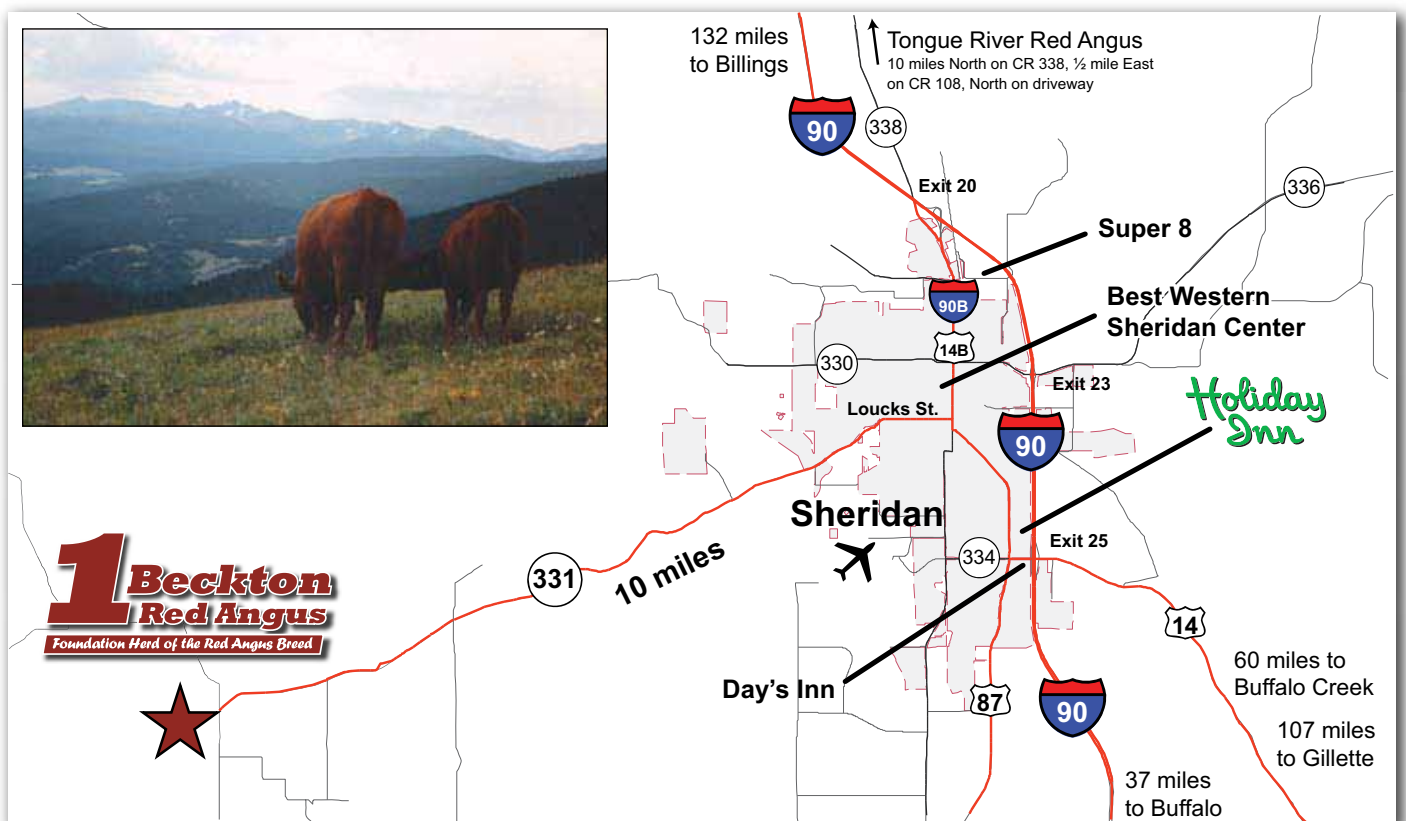

65th Anniversary Production Sale

Beckton Ranch

9½ miles West of Sheridan

Wednesday, April 14, 2010

1 o'clock pm

Lunch at noon

225 Bulls • 40 Heifers

Selling in catalog order, heifers sell following the bulls

Please join us for a complimentary dinner after the sale at the Holiday Inn.

Phone: 307.674.6095



Beckton Red Angus is the founding herd of the Red Angus breed. Started in 1945, it has since maintained the longest continuous performance testing and improvement program in the industry.

Some Facts about the Beckton Herd

- ▶ Beckton is the #1 herd for Low Maintenance Energy requirements, with the lowest average Cow Maintenance EPD of any major herd. Six of the top ten proven sires in the breed for lowest Maintenance Energy are Beckton sires. The average Beckton bull in this sale is in the top 5% of the entire breed for low Maintenance Energy EPD. **No other set of bulls will do a better job cutting your cowherd maintenance requirement and saving you money.**
- ▶ Beckton is also the #1 herd for easy calving, with the best average Calving Ease EPD of any major herd. Six of the top ten proven sires in the breed for low Birth Weight EPD are Beckton sires. The average Beckton bull in this sale is in the top 5% of the entire breed for calving ease. **No other set of bulls will do a better job giving you calving ease, for easier nights, and reducing calving loss.**
- ▶ Beckton bulls are leaders in total birth-to-market rate of growth. The average growth from birth to yearling weight EPD of these sale bulls is +62 !!- well above the average of the breed. **These are the bulls that give you not only low cowherd maintenance costs and higher calving ease, but also higher growth rate up to market age.**
- ▶ Beckton produces the top all-round carcass sires that combine Rib-eye and Marbling with Efficiency and Calving Ease. Beckton is producing the most "in-demand" sires in the breed, including Beckton Nebula M045 and Beckton Julian B571 – with top carcass traits and the breed's highest EPD rating for Stayability.
- ▶ Plus 65 years of selection for the convenience traits – good dispositions – cowherd fertility – good udders and milk. Our cattle grow up at high elevations in the Bighorn Mountains, as well as Wyoming range, so they offer excellent altitude adaptation and good feet and legs.
- ▶ There is no other sale offering which combines such good growth traits with this low cow maintenance and high calving ease, and in so many bulls.

The Foundation Herd of the Red Angus Breed – Serving our customers with industry leading genetics and the highest quality cattle – for 65 years.



Cam and Trish Forbes

Additional Sale Information

- ▶ The animals sell in catalog order.
- ▶ All animals are registered with the Red Angus Association of America, and registration certificates will be transferred to the new owners.
- ▶ All bulls selling have passed a rigorous fertility exam that included live semen evaluation, scrotal measurements, and reproductive tract examinations.
- ▶ Beckton has a comprehensive herd-wide health program which includes vaccinations for 7-Way, IBR, BVD, PI3, BRSV, Lepto, and ivermectin. The heifers are also vaccinated for bangs and vibrio.
- ▶ We plan to get semen collected on some of the bulls before the sale. Otherwise, we will work with the buyer to collect after the sale but before delivery.
- ▶ Since a DNA marker test for osteopetrosis (OS) was developed by RAAA a year ago, Beckton has tested every sire in use in our breeding program, as well as our major AI sires. We have now tested 73 current or recent Beckton-bred sires, from among all of our bloodlines. **All 73 have been tested OS Free.** We are comfortable there are no safer cattle than these. However, if you would like to have any sale bull tested, refer to the sale terms on page 79.
- ▶ From our earliest sales 40 or more years ago, Beckton has retained a 1/3 semen interest on every bull sold through our sales. This policy has had no effect for our commercial customers, who are not in the business of selling semen. To their benefit, it has meant that our commercial bull buyers have not had to compete with AI companies when they bid for their choice of bulls from our sale.

Here is further clarification. Some bulls are listed as selling ½ or other interest and full possession. For these bulls, both buyer and Beckton have the listed semen interest, and both have full rights to in-herd use as well as to market semen and issue certificates unless one or both parties lease its interest. Full possession goes to the buyer unless otherwise stated.

For all other bulls in the sale, Beckton retains a 1/3 semen interest. Full possession and salvage goes to the buyer, as well as the right to decide whether or not to collect a bull. Because we do not retain the right to require a bull to be collected, this 1/3 semen interest does not affect most of our customers, who can use the bull in any manner they wish. Those buyers interested in marketing semen from our bulls should read the Sale Terms on page 79.



Bob Hough and Sal Forbes



Doug Bingham



Spike and Jo

Table of Contents

The Beckton Program	4
The Bulls	10
The Yearling Heifers	55
Reference Sires.	64
RAAA Herd EPD Tables	74
Sire Bloodline Charts.	76
Lot-Tag Cross Ref	78
Sale Terms & Conditions	79
Semen Available	80



Tommy "T.V." Jones
Record Stockman
307.632.5118



Doug Hogan
Tri-State
Livestock News
605.391.5346



Curt Cox
Wyoming Livestock
Roundup
307.630.4604



Jerry Gliko
Western Livestock
Journal
406.656.2515



Alan Sears
Western Livestock
Reporter
970.454.3986



Del Tinsley
Wyoming Livestock
Roundup
307.234.2700



Eric Mack
Wyoming Stockman
Farmer
406.366.2111

Credit for many of the photographs in the catalog should go to Kim Wolfe (*Record Stockman*), Doug Hogan (*Tri-State*), Brenda Stewart, and Diane Vaneck.

THE WALDO FORBES FAMILY
Sal; Spike and Jo; Cam and Trish;
Doug and Sheila; Cherry and John
Julia and Ed; Sarah and Doug;
Elfie and Ruth



REGISTERED RED ANGUS CATTLE AT
Foundation Herd of the Red Angus Breed
Serving You since 1945
BECKTON STOCK FARM
37 Beckton Drive
SHERIDAN, WYOMING 82801
Phone (307) 674-6095 day; 674-8162 evening; 672-7281 fax
beckton@wavecom.net



Dear Friends and Cattlemen,

On behalf of the Forbes family, we invite you to join us for our 65rd Anniversary Production Sale. We have a nice set of bulls and heifers this year. Following the sale, you are all cordially invited to a complimentary roast beef dinner in the Atrium at the Holiday Inn.

It is interesting to look at the offering this year, and look back at the sale offering from just 5 or 10 years ago. There is improvement in every measure of performance. The overall average yearling weight EPD's have increased from the +40's to nearly +60's, and weaning EPD's by the same proportion. Average birth weight EPD's have actually declined slightly, Carcass EPD's have improved substantially, as has milk EPD, and Stayability has gone from +7 to +14 in about 8 years. The increase in Stayability is particularly encouraging, because it means that our cattle are really working in other people's herds.

We had a very dry summer last year, but the bulls look good regardless. In keeping with our reputation, we offer only bulls which offer a high level of performance and structural soundness. We have also screened the bulls for disposition and made sure that anything which was questionable would not be in the sale. On the final weighing just recently, they were really quiet and easy to handle.

While the economy has had some problems, the future of the industry looks excellent. The national beef cow herd continues to decline, while export markets are re-gaining market share, and even the economy looks to be improving. Demand for energy likely will keep feed costs relatively high, but beef producers have alternatives, whereas pork and poultry do not.

The best management strategy to deal with high feed cost is to raise cattle which need less feed. Beckton has the leading genetics in the industry to moderate cow size and to reduce maintenance requirements. Our herd-wide cow maintenance energy EPD's are the lowest in the industry. We believe these bulls will do a better job producing the kind of mother cows that we are all going to need in the years ahead.

We are pleased with our bulls and heifers, and think we have a top selection to deliver to you. Two of the top bulls on test were Julian B571 sons, and we are offering them both. After the sale we hope you can join us for an early dinner at the Holiday Inn. If we can help you in any other way, just let us know.



Shelley, Stephen, Trish, Tallie, and Cam

Sincerely,

BRED-IN, NOT FED-IN, GENETIC SUPERIORITY
APRIL: SPRING BULL SALE FALL: RED ANGUS FEMALES
RED ANGUS BREEDING STOCK AVAILABLE YEAR ROUND

The Beckton Program

Cow Size

The goal for Beckton's program has always been to develop breeding seedstock which offer increased levels of performance for the commercial cattleman. Increased performance does not mean maximizing weight and size, which have already reached the upper limit of economic value for the packer and consumer. It does, however, mean increasing performance related to calving percentage and weaning percentage; and increasing performance related to cow maintenance requirements and "pounds of calf per acre" efficiency.

Size Matters

Beckton cattle are already big enough for the consumer and the packer. Using yearling weight EPD as the best available indicator of market size, the average for our sale bulls is +58. The Red Angus breed average for 2008-born animals is +56, so on market size our cattle are directly comparable to industry standard. They are comparable for weaning weight EPD also, so Beckton cattle offer weaning and yearling performance very similar to today's mainstream Red Angus.

The big difference between Beckton's program and others is that we select for additional weaning and yearling weight, but with the restriction that we have maintained about the same cow size as 30 years ago. In contrast, the industry has allowed cow size to increase at the same rate as calf size. Cow size is the largest factor determining maintenance requirements. Our goal over the past 30 years has been to increase efficiency, not size. No other seedstock breeding program has had such a goal, or maintained it for so long.

Beckton Cow Weight Average (lb.)

Year	1978	1982	1986	1990	1994	1998	2002	2006	2009
Wt.	1,126	1,126	1,064	1,115	1,067	1,125	1,104	1,093	1,102

(mature lactating cows taken at weaning)

Cow weights vary from year to year depending on body condition or other short term factors. But overall our cow size has stayed fairly constant over time.

The Industry Problem

As shown on the graph on the next page, industry-wide cow size has increased by around 25% over this same period. But look at the industry-wide trend in feed use per cow over the same period, shown by the use of hay:

Industry Hay Use (tons/animal unit)

Year	1978	1982	1986	1990	1994	1998	2002	2006	2007
Hay Usg.	1.43	1.62	1.91	2.00	1.94	1.99	2.08	2.05	2.04
Pct.	100%	113	134	140	136	140	146	143	143

(Src.: USDA Econ. Research Service, 2007 is newest available data)

Industry-wide, production per cow is up about 22%, but hay consumption per cow has risen over 40%.

Why does hay use increase at a faster rate than cow size or production per cow? Hay and grain are supplements to the cow's main diet, which is grass, and grass supply is relatively fixed by environment. Each increase in cow feed requirement must be met entirely by supplements, or by a combination of supplement and reduced stocking rate. A small increase in cow feed requirement leads to a reduction in stocking rate or a large increase in higher-cost, supplemental feed needs.

If any gains have been achieved in the feedlot sector due to increased animal growth, they have been overwhelmed by increased cost of production in the cow-calf sector.

The Beckton Year-Round Crew:



Tom Peek



Randy Zier



Mick McClure



Alan Sanders

Efficiency

30 Years of Change: Industry-Wide

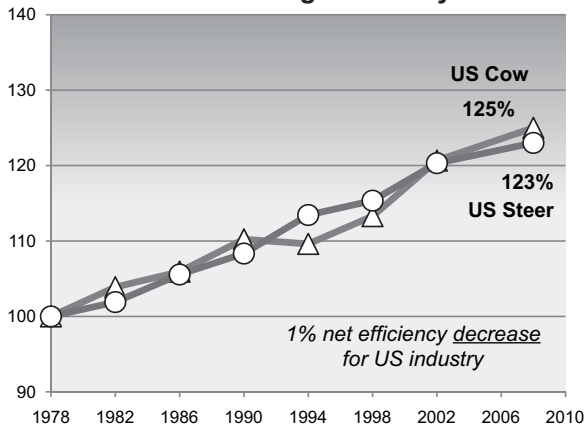

The graph at left shows how, for the U.S. cattle industry overall, the increase in average calf weights, as measured by steer slaughter weights, has been directly matched by an increase in average cow weights. (Percentages are based on USDA slaughter weight data for steers and cows respectively, using 1978 as a base year. Data for heifers slaughtered shows an identical trend.) Over 30 years, there has been minimal change in overall cowherd efficiency.

This graph shows the failure of cross-breeding and composite breeding to do little more than simply increase general cattle size. In the promotion of composites, the impact of retained heterosis on mature weight is too often ignored. Crossbreeding and composites are sold as a free lunch, but they aren't necessarily free after all.

We have accomplished this by selecting for growth, restricting birth weight and cow size creep, and multiplying each incremental change rapidly throughout our entire cowherd and all of our bloodlines. Usually this has meant working within our own bloodlines rather than introducing out-crosses, because the outside genetics for the direction we wanted to go haven't been available. The overall key to success is simply that we have been making small progress in multiple traits, but doing it consistently over a very long period of time.

30 Years of Change: Beckton

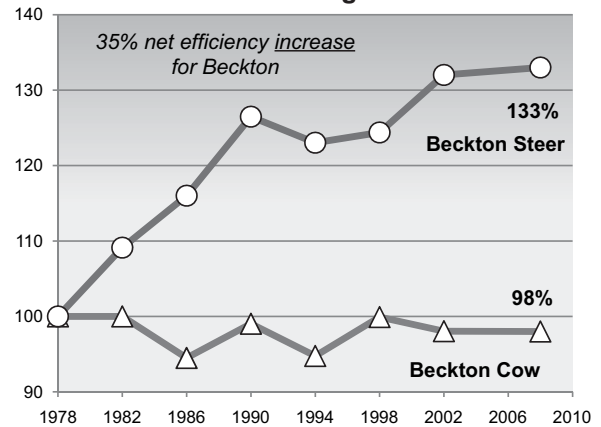

The graph at right shows Beckton cowherd data over the same time period.

1. Beckton cow size has shown negligible change over the past 30 years, while the industry has experienced a substantial increase in cow size.
2. Even without increasing cow size, we have raised the rate of early growth in Beckton cattle, using intense genetic selection and generation turnover, and by more than the rest of the industry.
3. The net change in efficiency as measured simply by "calf weight divided by cow weight", is significantly higher with Beckton's genetic program, compared to mainstream cross-breeding based on retained heterosis.

These eight combine for 130 years at Beckton



Sherry Kobielus



Seth Tomisich



Travus Adsit



Jane Redding

Management

One Bull – the Simple Solution is the Best Solution

Many cattlemen use Beckton bulls for their heifers because of their low birth weights and high calving ease. Our bulls are even better when used on cows, because replacement heifers tend to be selected from calves out of older cows. **Keeping replacement heifers sired by Beckton bulls is the quickest way to limit cow size creep and to moderate cow size for the future.** In our own program we use the same bulls on both heifers and cows. Every bull is used his first year with heifers to evaluate calving ease, and used in future years with older cows. We get calving ease, growth, and moderate-sized replacements, all with the same bull.

Quietness and Ease of Handling

The necessity of record keeping means that our cattle will be handled much more than commercial cows. **This benefits our seedstock customers because our cattle will be quieter and easier to handle.** Good disposition is one of our most valued traits.

Selection for Industry Requirements

In order to make selection decisions appropriate to the commercial beef industry, seedstock cattle need to be managed and measured under conditions which will approximate the commercial industry. **Our cows are run strictly on grass, with hay only if weather conditions require it, because that is how the commercial industry runs cows.** However, almost all commercial calves go into feedlots before slaughter, so feedlot performance and efficiency is an important trait for calves. **Simply put, a producer needs to know how his cows perform on grass, and how his calves perform with feed.**

Our bulls are run on a performance test designed to provide the fairest basis of comparison among them, and

this requires a compromise. Our bulls receive a “growing” ration high in roughage and protein and not as high in energy as a steer would receive. **We want to get a good measure of gainability with which to compare bulls, but we don’t want the bulls fat.**



*Craig Uden, Darr Feedlot Manager
Photo courtesy of the Lexington Clipper-Herald*

Craig Uden, Mitch Ziebell of Darr, NE

In the fall of 2005, Lane Kugler retired and sold his bull testing facility to a neighboring operation - Craig Uden with Darr Feeders. **The name change is somewhat misleading, because the bulls are still in the same pens they have always been in.** Unlike the Kugler’s, Craig actually runs a complete operation vertically integrated from commercial cow-calf production all the way to the packer door. Bull testing is a natural fit. Craig Uden started at Darr in 1984, and has served on numerous committees and organizations in Nebraska. Mitch Ziebell has joined him and has taken over responsibility for the daily management of our bulls at Darr. **We have been very impressed with what conscientious care Mitch oversees all aspects of the bull management.**

Contributing to the success of the Beckton Program...



*Sarah and Mark
Schreiber
Our vets*



*Cody Cunningham
Brand Inspector*



*Charles Larsen
Brand Inspector*



*Dr. Robert Bohlender
Fertility tests
the bulls*



*Matt Goold
Clips and washes
the bulls*



*Bob Milner
Our AI tech*

Using New Selection Tools

Maintenance EPD

This EPD predicts the relative feed energy requirement for maintenance, for cows produced by a sire or female. A bull with an ME of -3 (minus 3) is expected to sire replacement daughters which will need 10 fewer mcals of energy per month than a bull with an ME of +7.

We believe this is an important EPD because feed costs, both direct and indirect through ranch overhead, make up by far the largest proportion of operating costs. It can have much more direct impact on ranch profitability than Marbling or Ribeye EPD for example.

The Beckton herd is the breed's top herd for low maintenance energy requirements, with the lowest average herd ME of any major herd, based on all sires listed on National Sire Evaluation. **The average Beckton cow is in the top 4% of the entire breed for lowest Maintenance Energy requirement.**

Calving Ease

The Red Angus Calving Ease EPD was introduced in 2003, and is a more direct measure of calving ease than birth weight alone. Calving Ease is defined as follows: "The expected differences of calving ease measured as the probability difference (between sires) of unassisted calvings among offspring." For Calving Ease EPD, the higher number is better.

There are two Calving Ease EPDs – "Direct", a predictor of an animal's own offspring; and "Maternal", a predictor of a daughter's calving ease. Unless stated otherwise, we publish the Calving Ease Direct because most of our customers' primary concern is selecting bulls for use on first calf heifers.

Beckton's average Calving Ease EPD is +13, seven points higher than the Red Angus breed average of 6, due to our long history of selection for moderate birth weights. **The average Beckton bull is in the top 4% of the entire breed for highest Calving Ease.**

Cow Efficiency

We present two indicators of efficiency. The first is Weaning Percent, a simple percentage of calf 205 day weight divided by the dam's actual weight at weaning. The second is PRI Cow Efficiency. This also measures calf weaning weight, but relative to the cow's metabolic weight, and is expressed as an index above or below 100.

These efficiency measures are best used as indicators of where an animal is relative to others, rather than directly for selection. For example, if we see an animal with a low efficiency, we would look at the actual calf and cow weights to decide if the calf is too small, or the cow too big for the environment. That in turn will suggest corrective actions. **In general, select for the traits you need to change to make cattle more efficient, and efficiency will be the result.**

After 64 years of this performance selection, we believe our cattle are the most efficient in the industry.

Dam Information

A significant difference with our catalog is the greater amount of information about the dams we provide. Weaning percent and Cow Efficiency are explained above. In addition and next to each sale animal, we give the dam's age when that calf was born, and the dam's actual weight when the calf was weaned last fall. We also provide her progeny averages – the average birth weight, weaning ratio, and yearling ratio, of her calves.



Additional Facts about the Beckton Program

- Birth weight**
- ▶ Every sire entering our own program is used first on our own heifers, then on our cows.
 - ▶ We have never used high birth weight sires in any part of our program, so big birth weights are rare.
 - ▶ We get the pay weight, but with lower birth weights and greater calving ease.
 - ▶ Full production from heifers. We use the same bulls on heifers and cows.

- Growth**
- ▶ Weaning efficiency, and rate of gain to slaughter weight second to none.
 - ▶ Growth traits must be consistent with maintaining maternal qualities.
 - ▶ Beckton cattle are ideally sized for today's packer demand.

- Hardiness**
- ▶ Every cow in the herd has spent part of her life in the Big Horn Mountain summer range, at elevations from 7,000 to 10,500 feet.
 - ▶ In 2001 we PAP tested all of our herd sires. The herd average PAP score was 32.5 at 4000', equivalent to a herd average PAP of 39 at 8000' (excellent scores).
 - ▶ By the time she is 5, our average cow will have been trailed over 80 miles, above and beyond normal pasture rotation.

- Efficiency**
- ▶ The typical dam of our bulls weans over 50% of her body weight in 205 days, under range conditions, with no creep-feeding.
 - ▶ The average dam produces over 100% of her own body weight in a year.
 - ▶ The average mature cow (age 5+) weighs about 1100-1125 pounds.

- Fertility**
- ▶ Every bull in our program is used in natural service, with 30-50 heifers/cows.
 - ▶ Every cow in our program must cycle naturally and breed early under range conditions.

- Value**
- ▶ Beckton Red Angus produce more growth without high birth weights.
 - ▶ They are the one-bull solution that can be used on both heifers and cows.
 - ▶ Carcass quality is an extra benefit.

- Reliability**
- ▶ Beckton has been genetically improving Red Angus since 1945, a 30-60 year lead time over other producers.
 - ▶ It is a complete, genetically sound breeding program, which demands whole-herd performance.



*Sue and Forest Dunning
Tongue River Red Angus, 307.750.2454*



*Joe and Connie Mushrush
Mushrush Red Angus, 620.273.8581*

The Other Friends and Family who help us in many ways over the course of the year

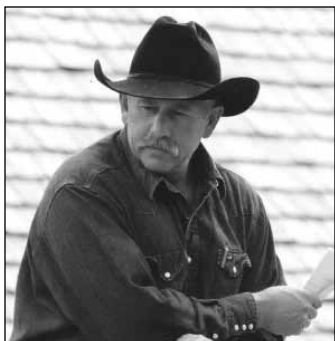

Dave Nelson



*Sarah, Ellen, Julia,
and Katie Durkin*



Ruth Sylvester



*Julia Forbes and Ed Waddington
(with Tazmin and Flinder)*



Roger Zier



Spike with Julia Durkin



Sal Forbes and Elfie Forbes



Doug Foster and Sarah Forbes



*Don Bingham, Alison Brody,
and Kate Bingham*



Mary Ellen McWilliams, Joy Miller, and Mary Nelson

The Bulls

Our bulls are managed to give our customers many years of productive service. We have been testing breeding bulls for 45+ years, longer than almost anyone. Our own breeding is based on natural service, not AI, so we see how bulls work in the pasture. We use these bulls with our own cows, on every kind of terrain and high in the Big Horn Mountains. For the first twenty years our bulls were raised and tested at home here in Wyoming. They received some grain, but otherwise grass pasture and dry hay – a forage dominated diet. In 1979 we moved our test to the Kugler's in Nebraska, where the bulls got a ration including silage, corn and protein.

It was 30 years ago that we started bringing home from Kuglers, and used them with our own cows. The improvement in libido and breeding performance in these bulls was dramatic. While it is possible to feed bulls improperly under any program, we would strongly question those who promote the notion of any advantage to “forage-raised” bulls.

We have used over 400 of these bulls in our own herd, and have never had a bull fall out of our program prematurely due to his feeding or testing management. Beckton Julian B571, Lancer F442, and all of our other great sires were fed and tested at the Kugler facility. We think any notion that forage raised bulls will somehow hold up better or last longer, lacks validity.



We do not publish a list of Ultrasound ratios, because for most commercial people they are not a focus of selection. It should be noted that when we do mention them, the ratios may not agree with those calculated by RAAA. The difference is contemporary groups. For ratios we present, we use the same contemporary groups that we use for other yearling ratios. Sometimes a contemporary group may be larger than RAAA might have used, resulting in some difference in the actual number. We prefer this methodology because it reduces some misleading extremes in ratios that can occur when contemporary groups are too small.

1 BECKTON NEBULA W343 L4

1-A 100% # 1332042 Tattoo: BKT9 W343

Birth: 3-21-09

Beckton Nebula E P084
 Beckton Nebula M045
 BKT Pine Marie M119 EP

BECKTON NEBULA EN S347
 Ref. N-7
 Beckton Eola P530 NB
 Beckton Nebula M045
 Beckton Eola M663 EP

Beckton Lancer TL G626
 Beckton Lancer T A664
 Beckton Fayette C110 LN

BECKTON LANA L538 LN
 Beckton Lana G514 CD
 Beckton Cody C401
 Beckton Lana 9610 TP

DAM		Calv.Ease	BW	WW	YW	Milk	HPG	Stay	Maint.En.
Age	8	16	-5.6	23	51	16	9	15	-6.3
Wt	1140	Marb +0.24		REA +0.14		Bfat +0.01			
Prog.BW	73	BWt	WWt	WR	ADG	YWt	YR	Scr.	Fr.
WR	107	69	670	113	4.14	1166	110	42	5.0
YR	104								
Wean Pct.	59%								
Cow Eff.	124								

Leading the sale is what we think to be one of the best "cowman's" bulls in the sale. Not extreme, but he has it all - very low Maintenance EPD; very high calving ease; very high yearling weight ratioed against his peers; very high Stayability EPD with solid Milk; lots of meat with Ultrasound ratios of 120 for Marbling and 112 for Ribeye; the biggest scrotal in the sale. And his mother is a wonderful proven eight-year old Lana, weighing a perfect 1140 lbs., who has weaned every calf in the top half of the herd. **Selling ½ Interest & Full Possession.**



Beckton Julian GG B571, Ref. J-1
Sire of Lots 2 and 3

3 BECKTON JULIAN W372 L4

1-A 100% # 1332028 Tattoo: BKT9 W372

Birth: 3-22-09

Beckton Julian 7526G
 Beckton Julian 6592
 Bkt Belga 6746 GS

BECKTON JULIAN GG B571
 Ref. J-1
 Bkt Marta 9A13 JL
 Beckton Julian 7526G
 Bkt Marta 6498 XM

Beckton Loki F251
 Beckton Lancer TZ D525
 Bkt Pine Marie D126 JL

BECKTON SIERRA K557 LO
 Beckton Sierra C157 CL
 Beckton Clipper JL A095
 Beckton Sierra A086 CL

DAM		Calv.Ease	BW	WW	YW	Milk	HPG	Stay	Maint.En.
Age	NA	19	-5.7	29	61	16	9	18	-3.1
Wt	1180	Marb +0.14		REA +0.19		Bfat +0.01			
Prog.BW	71	BWt	WWt	WR	ADG	YWt	YR	Scr.	Fr.
WR	108	65	617	115	4.05	1160	113	41	5.0
YR	107								
Wean Pct.	52%								
Cow Eff.	110								

A second great opportunity at a top B571 son. W372 ranked even higher on yearling weight on test, with lower birth weight, and really spreads birth and yearling growth. Like his brother, his scrotal is near the top of the bulls. His Sierra dam is a cow we thought so highly of that we selected her as one of the few cows in our herd to flush for ET. Her progeny record shows her performance. **Selling ½ Interest & Full Possession.**



2 BECKTON JULIAN W293 L4

1-A 100% # 1332065 Tattoo: BKT9 W293

Birth: 3-19-09

Beckton Julian 7526G
 Beckton Julian 6592
 Bkt Belga 6746 GS

BECKTON JULIAN GG B571
 Ref. J-1
 Bkt Marta 9A13 JL
 Beckton Julian 7526G
 Bkt Marta 6498 XM

Beckton Loki F251
 Beckton Lancer TZ D525
 Bkt Pine Marie D126 JL

BECKTON LYDIA M607 LO
 Beckton Lydia J801 CD
 Beckton Cody V E023
 Beckton Lydia D559 CF

DAM		Calv.Ease	BW	WW	YW	Milk	HPG	Stay	Maint.En.
Age	7	7	0.2	24	66	11	11	17	-4.7
Wt	1160	Marb +0.20		REA +0.19		Bfat +0.01			
Prog.BW	75	BWt	WWt	WR	ADG	YWt	YR	Scr.	Fr.
WR	104	79	638	107	3.92	1163	109	41	5.0
YR	104								
Wean Pct.	55%								
Cow Eff.	116								

Beckton Julian B571 is the great proven sire in the breed, with great herd sire sons all over the country. This year we had only two sons, but they both finished near the top of the test. Lot 2 could be one of the greatest B571 sons ever. Out of a real nice, proven, high performance, moderate size Lydia dam. Low maintenance, huge scrotal, and Ultrasound ratios of 109 for Ribeye and 134 for Marbling. **Selling ½ Interest & Full Possession.**

4 BECKTON ACCENT W226 L2

1-A 100% # 1331669 Tattoo: BSF9 W226

Birth: 3-15-09

Beckton Cody KH M390
 Beckton Cody K G701
 Beckton Tamara J124 HR

BECKTON CODY K1 P014
 Ref. C-1
 Beckton Rose M126 WR
 Beckton Warrior T C371
 Beckton Rose D741 LN

Beckton Loki F251
 Beckton Lancer TZ D525
 Bkt Pine Marie D126 JL

BECKTON INDIGO LC22 LO
 Beckton Indigo E370 RN
 Beckton Ranger H Z095
 Beckton Indigo A735 LN

DAM		Calv.Ease	BW	WW	YW	Milk	HPG	Stay	Maint.En.
Age	8	11	-2.2	26	62	19	5	12	1.7
Wt	1180	Marb +0.05		REA +0.03		Bfat -0.01			
Prog.BW	77	BWt	WWt	WR	ADG	YWt	YR	Scr.	Fr.
WR	107	80	642	108	4.41	1198	112	38	5.5
YR	102								
Wean Pct.	54%								
Cow Eff.	115								

This Accent son was Mitch Ziebell's top overall pick from every bull we had on test this winter - the only bull to get a perfect 10. We had Lot 4 DNA profiled also, and he scored a perfect 10 on Igenity's scale to measure Tenderness. He has loads of performance, and his Indigo dam is a 10 also - 10 years of age and a 10 for progeny performance. **Selling ½ Interest & Full Possession.**

5 BECKTON HERITAGE W027 J3

1-A 100% # 1332491 Tattoo: BKT9 W027

Birth: 2-22-09

Beckton Heritage N013
 Beckton Hustler C2 L079
 Beckton Lana L007 JL
BECKTON HERITAGE T270 J2
 Ref. H-3 Beckton Coca P602 JL
 Beckton Julian GG B571
 Beckton Coca J270 CD
 Beckton Justice CH M056
 Beckton Justice C K449
 Beckton Ruth K802 HD
BECKTON LARKABA T813 JC
 Beckton Larkaba P645 JL
 Beckton Julian GG B571
 Beckton Larkaba L312 LN

DAM		Calv.Ease	BW	WW	YW	Milk	HPG	Stay	Maint.En.
Age	2	15	-2.6	37	75	15	11	17	-5.4
Wt	775								
Prog.BW	65								
WR	112		Marb	+0.21	REA	+0.24	Bfat	-0.01	
YR	114								
Wean Pct.	70%	BWt	WWt	WR	ADG	YWt	YR	Scr.	Fr.
Cow Eff.	147	65	599	112	3.74	1125	114	35	5.5

The best overall EPD's in the sale, the way we see them. Heritage W027 does everything. Given that calves out of two year old's usually don't get the same start as cows out of older cows, his performance, statistics, and looks are phenomenal. His Ultrasound ratios were outstanding also - Ribeye 112 and Marbling 124. **Selling ½ Interest & Full Possession.**



6 BECKTON NEBULA W312 L3

1-A 100% # 1332011 Tattoo: BKT9 W312

Birth: 3-20-09

Beckton Nebula M045
 Beckton Neptune R2 K065
 Beckton Belga K285 JL
BECKTON NEBULA H R233
 Ref. N-4 Beckton Coca H132 HD
 Beckton Hadrian F C486
 Beckton Coca CB74 JV
 Beckton Lancer TZ D525
 Beckton Marta Z381 CL
BECKTON LAKME J460 LT
 Beckton Lakme G128 HD
 Beckton Hadrian FC E166
 Beckton Lakme E373 CL

DAM		Calv.Ease	BW	WW	YW	Milk	HPG	Stay	Maint.En.
Age	10	15	-6.1	18	55	17	11	12	-1.8
Wt	1180								
Prog.BW	75								
WR	106		Marb	+0.02	REA	+0.26	Bfat	+0.00	
YR	107								
Wean Pct.	48%	BWt	WWt	WR	ADG	YWt	YR	Scr.	Fr.
Cow Eff.	101	68	566	95	4.01	1125	105	38	5.5

It seems to work that top sires connect to top cows. Here the dam is a ten year old Lakme line cow that consistently produces well, and is the dam of one of our good four year old herd sires - Beckton Loki S284, Ref. Sire L-2. Most people associate Beckton with Julian, Lancer and Nebula, but look at just the few bulls at the front of this sale and see how many times you see Loki on the dam side of the pedigree. Lancer D525 is the sire of Loki, and also the maternal great-grand sire of Lot 6. And his Ultrasound ratios are Marbling 106 and Ribeye 116 **Selling ½ Interest & Full Possession.**

7 TR JUBILATION WT981

1-A 100% # 1324467 Tattoo: TR2A9 WT98

Birth: 2-18-09

Beckton Julian GG B571
 BKT Julian 7526 G
 BKT Marta 9A13 JL
TR JULIAN LT142
 Ref. TR Lana G760
 Beckton Cody V E023
 Beckton Lana E828 SC
 Beckton Julius M213
 BKT Julian 7526 G
 Beckton Lana H128 HR
TR DYNA ST669
 TR Dyna LT111
 Beckton Julian GG B571
 BSF Dyna JT976

DAM		Calv.Ease	BW	WW	YW	Milk	HPG	Stay	Maint.En.
Age	3	19	-3.5	34	62	18	16	16	-6.8
Wt	NA								
Prog.BW	NA								
WR	NA		Marb	+0.06	REA	+0.10	Bfat	+0.00	
YR	NA								
Wean Pct.	NA%	BWt	WWt	WR	ADG	YWt	YR	Scr.	Fr.
Cow Eff.	NA	75	626	106	3.42	1173	104	NA	5.0

TR Jubilation WT981 showcases the balanced attributes of his famous sire Julian LT142 and grandsire Julian B571. He is in the top 1% of the breed for the maternal traits of CED, Maintenance, HPG, and CEM, and the top 3% for Stayability, while ranking in the top half of the breed for the revenue traits as well. **Selling ½ Interest & Full Possession.**

8 TR NEBULA WT952

1-A 100% # 1324424 Tattoo: TR2A9 WT95

Birth: 2-14-09

Beckton Neptune R2 K065
 Beckton Neptune RR B284
 Beckton Lana C735 TP
BECKTON NEBULA M045
 Ref. Beckton Belga K285 JL
 Beckton Julian GG B571
 Beckton Belga G493 HR
 Beckton Lancer T A664
 BKT Kuruba 9727 RV
BSF DYNA JT976
 Buf Crk Dyna 3082
 Buf Crk Hobo 1961
 Buf Crk Dyna 1777

DAM		Calv.Ease	BW	WW	YW	Milk	HPG	Stay	Maint.En.
Age	10	13	-2.4	33	65	9	11	13	-1.4
Wt	NA								
Prog.BW	NA								
WR	NA		Marb	+0.11	REA	+0.16	Bfat	+0.00	
YR	NA								
Wean Pct.	NA%	BWt	WWt	WR	ADG	YWt	YR	Scr.	Fr.
Cow Eff.	NA	85	681	115	3.51	1243	110	NA	6.0

TR Nebula WT952 reflects the best of Tongue River and Beckton genetics. He scores in the top 25% of the breed in all five of the maternal traits and still ranks in the top third of the breed for the revenue traits of Yearling weight and Ribeye. He was Tongue River's highest gaining bull on test at 4.59 lbs. per day. **Selling ½ Interest & Full Possession.**



Sue and Forest Dunning
 Tongue River Red Angus, 307.750.2454

• Bulls •

9 **BECKTON EPIC W460 V5**
1-A 100% # 1331640 Tattoo: BSF9 W460

Birth: 3-26-09
 Beckton Epic KJ J722
BECKTON EPIC K4 N795
 Ref. E-1
 Beckton Sierra J789 EP
 Beckton Epic K F075
 Beckton Lana F891 JL
 Beckton Epic D404
 Beckton Sierra C157 CL
 Beckton Vegas S F382
 Beckton Lana F268 CT
 Beckton Herald HH E503
 Beckton Lana B269 JL
BECKTON LANA K093 VG
 Beckton Vegas SC H209
 Beckton Lana H349 HR

DAM		Calv.Ease	BW	WW	YW	Milk	HPG	Stay	Maint.En.
Age	NA	6	-0.4	41	86	16	6	11	4.7
Wt	1225	Marb +0.08		REA +0.26		Bfat +0.01			
Prog.BW	81	BWt	WWt	WR	ADG	YWt	YR	Scr.	Fr.
WR	119	79	741	139	4.32	1294	126	40	5.5
YR	113								
Wean Pct.	61%								
Cow Eff.	127								

Lot 9 is the highest yearling weight 1-A bull on our entire test this year. For the dry year we had last summer, his weaning weight is off the charts. His Lana dam is also off the charts - almost certainly the highest performing cow in our herd. Her calves do it at both weaning and yearling, and the birth weights are very reasonable. His scrotal is powerful, and his ultrasound Rib-eye measure of 15.4 is one of the very biggest. **Selling ½ Interest & Full Possession.**



Dianne Vanek
 Beckton Epic K4 N795, Ref. E-1
 Sire of Lots 9 and 11

10 **BECKTON NEBULA W176 C3**
1-A 100% # 1332024 Tattoo: BKT9 W176

Birth: 3-12-09
 Beckton Nebula M045
BECKTON NEBULA L P093
 Ref. N-2
 Beckton Marta M021 LN
 Beckton Neptune R2 K065
 Beckton Belga K285 JL
 Beckton Lancer TA K644
 Beckton Marta K254 LN
 Beckton Copper J E616
 Beckton Ruth E549 TP
BECKTON COCA K480 CO
 Beckton Copper JT G095
 Beckton Coca C178 VG
 Beckton Vegas 9433
 Beckton Coca 8372 TJ

DAM		Calv.Ease	BW	WW	YW	Milk	HPG	Stay	Maint.En.
Age	NA	13	-3.2	28	59	9	12	14	-5.2
Wt	1120	Marb +0.13		REA +0.13		Bfat -0.01			
Prog.BW	66	BWt	WWt	WR	ADG	YWt	YR	Scr.	Fr.
WR	100	71	622	116	4.23	1173	114	41	6.0
YR	100								
Wean Pct.	56%								
Cow Eff.	117								

★★★★★ for Low Maintenance, Gainability, Marbling, Rib-eye area, High Cow Efficiency, Calving Ease, Stayability. **Selling ½ Interest & Full Possession.**

11 **BECKTON EPIC W556 L5**
1-A 100% # 1332161 Tattoo: BKT9 W556

Birth: 4-1-09
 Beckton Epic KJ J722
BECKTON EPIC K4 N795
 Ref. E-1
 Beckton Sierra J789 EP
 Beckton Epic K F075
 Beckton Lana F891 JL
 Beckton Epic D404
 Beckton Sierra C157 CL
 Beckton Lancer F442 T
 Beckton Minola E589 TO
BECKTON ROSE R152 LS
 Beckton Laser N602
 Beckton Rose N607 CO
 Beckton Copper JT G095
 Beckton Rose J725 EP

DAM		Calv.Ease	BW	WW	YW	Milk	HPG	Stay	Maint.En.
Age	4	6	-0.2	30	75	13	4	15	2.2
Wt	1040	Marb +0.24		REA +0.10		Bfat +0.01			
Prog.BW	74	BWt	WWt	WR	ADG	YWt	YR	Scr.	Fr.
WR	102	84	588	101	4.14	1161	108	35	6.0
YR	108								
Wean Pct.	55%								
Cow Eff.	115								

The bloodline which gets the most inquiries from customers looking for genetics to complement Julian and Lancer, is Epic. Beckton Epic N795 is our top proven Epic - a standout sire who regularly gives us top herd bulls. Like Lot 9, Lot 11 is a high performance bull with growth and carcass, and Ultrasound ratios of Marbling 125 and Ribeye 103. What doesn't show is that Epic N795 has more daughters producing in our herd than any other sire his age or younger - he is a female producer too. **Selling ½ Interest & Full Possession.**

12 **BECKTON NEBULA W154 N3**
1-A 100% # 1332411 Tattoo: BKT9 W154

Birth: 3-10-09
 Beckton Nebula M045
BECKTON NEBULA T269 E2
 Ref. N
 Beckton Ruth M967 EP
 Beckton Neptune R2 K065
 Beckton Belga K285 JL
 Beckton Epic KN H110
 Beckton Ruth A905 SG
 Beckton Nebula M045
BECKTON COCA T419 NB
 Beckton Coca P459 LN
 Beckton Lancer F442 T
 Beckton Coca H192 VG

DAM		Calv.Ease	BW	WW	YW	Milk	HPG	Stay	Maint.En.
Age	2	12	-2.1	35	74	11	11	14	-6.5
Wt	890	Marb +0.12		REA +0.25		Bfat +0.00			
Prog.BW	66	BWt	WWt	WR	ADG	YWt	YR	Scr.	Fr.
WR	107	66	573	107	3.51	1083	110	36	5.5
YR	110								
Wean Pct.	58%								
Cow Eff.	121								

Linebred Nebula M045 - this future herd sire really puts it all together - low Maintenance, growth, calving ease, carcass. His Ultrasound ratios are Marbling 126 and Ribeye 106, and he's out of just a two year old, but a very good two year old. He has Lancer F442 and Epic on the dam sides - and with the line-breeding possibly the most potential of any sire in the sale. **Selling ½ Interest & Full Possession.**

13 **BECKTON EMCEE W328 N2**
1-A 100% # 1331823 Tattoo: BSF9 W328

Birth: 3-20-09
 Beckton Epic K4 N795
BECKTON EMCEE S466
 Ref. E-4
 Beckton Larkaba H798 WR
 Beckton Epic KJ J722
 Beckton Sierra J789 EP
 Beckton Warrior T C371
 Beckton Larkaba E042 CD
 Beckton Neptune R2 K065
BECKTON BARMAID R705 NB
 Beckton Nebula M045
 Beckton Barmaid L772 LN
 Beckton Belga K285 JL
 Beckton Lancer TS D390
 Beckton Barmaid H504 HD

DAM		Calv.Ease	BW	WW	YW	Milk	HPG	Stay	Maint.En.
Age	4	13	-3.4	24	56	11	9	13	-2.9
Wt	990	Marb +0.11		REA +0.30		Bfat +0.00			
Prog.BW	67	BWt	WWt	WR	ADG	YWt	YR	Scr.	Fr.
WR	95	75	558	94	4.28	1098	103	35	5.0
YR	97								
Wean Pct.	54%								
Cow Eff.	114								

★★★★★ for Low Maintenance, Gainability, Marbling, Rib-eye area, Calving Ease, Stayability. **Selling ½ Interest & Full Possession.**

• Bulls •

14 BECKTON NEBULA W498 J3

1-A 100% # 1331953 Tattoo: BSF9 W498

Birth: 3-28-09

Beckton Nebula M045
BECKTON NEBULA L P093
 Ref. N-2

Beckton Neptune R2 K065
 Beckton Belga K285 JL

Beckton Lancer TA K644
 Beckton Marta K254 LN

Beckton Justice C2 R695
BECKTON ROSE T266 JC
 Beckton Rose R711 LN

Beckton Justice CH M056
 Beckton Tamara M878 JC

Beckton Lancer T6 M467
 Beckton Rose L311 LN

DAM		Calv.Ease	BW	WW	YW	Milk	HPG	Stay	Maint.En.
Age	2	15	-5.0	30	72	12	12	14	-0.1
Wt	825								
Prog.BW	55								
WR	114								
YR	115								
Wean Pct.	67%								
Cow Eff.	140								
		Marb			REA			Bfat	
		BWt	WWt	WR	ADG	YWt	YR	Scr.	Fr.
		55	608	114	4.14	1133	115	35	5.0

★★★★★ for Low Maintenance, Growth, Gainability, Marbling, Rib-eye area, Superior Cow, High Cow Efficiency, Calving Ease, Stayability. **Selling ½ Interest & Full Possession.**

17 BECKTON EPITOMY W191 J2

1-A 100% # 1332087 Tattoo: BKT9 W191

Birth: 3-13-09

Beckton Epic K4 N795
BECKTON EPITOMY S250
 Ref. E-3

Beckton Epic KJ J722
 Beckton Sierra J789 EP

Beckton Julian GG B571
 Beckton Tara J266 HR

Beckton Julio L233
BECKTON TAMARA N180 JO
 Beckton Tamara L132 CT

Beckton Julian G1 J526
 Beckton Rose J725 EP

BKT Clifftop T2 J059
 Beckton Tamara J201 CH

DAM		Calv.Ease	BW	WW	YW	Milk	HPG	Stay	Maint.En.
Age	6	14	-4.6	22	56	18	7	16	-1.9
Wt	1110								
Prog.BW	66								
WR	105								
YR	101								
Wean Pct.	59%								
Cow Eff.	125								
		Marb			REA			Bfat	
		BWt	WWt	WR	ADG	YWt	YR	Scr.	Fr.
		68	658	110	3.56	1151	108	39	5.5

★★★★★ for Low Maintenance, High Cow Efficiency, Calving Ease, Stayability. **Selling ½ Interest & Full Possession.**

15 TR EPIC WT989

1-A 100% # 1324414 Tattoo: TR2A9 WT98

Birth: 2-6-09

Beckton Epic K F075
TR EPIC ST618
 Ref.

Beckton Epic D404
 Beckton Belga D483 KR

Beckton Julian GG B571
 Beckton Kit A517 NP

TR Julian LT142
TR LYDIA TT731
 TR Lydie PT457

Beckton Julian GG B571
 TR Lana G760

Beckton Lancer T A664
 Beckton Lydia E251 CL

DAM		Calv.Ease	BW	WW	YW	Milk	HPG	Stay	Maint.En.
Age	2	12	-1.1	35	64	14	12	15	-6.6
Wt	NA								
Prog.BW	NA								
WR	NA								
YR	NA								
Wean Pct.	NA%								
Cow Eff.	NA								
		Marb			REA			Bfat	
		BWt	WWt	WR	ADG	YWt	YR	Scr.	Fr.
		70	637	111	3.59	1212	106	NA	5.0

★★★★★ for Low Maintenance, Growth, Marbling, Rib-eye area, Calving Ease, Stayability. **Selling ½ Interest & Full Possession.**



16 TR NEBULA WT972

1-A 100% # 1324474 Tattoo: TR2A9 WT97

Birth: 2-17-09

Beckton Neptune R2 K065
BECKTON NEBULA M045
 Ref.

Beckton Neptune RR B284
 Beckton Lana C735 TP

Beckton Julian GG B571
 Beckton Belga G493 HR

Beckton Julius M213
TR SIERRA RT517
 BSF Sierra KT049

BKT Julian 7526 G
 Beckton Lana H128 HR

Beckton Julian GG B571
 TR Sierra G715

DAM		Calv.Ease	BW	WW	YW	Milk	HPG	Stay	Maint.En.
Age	4	13	-1.4	36	66	7	16	14	-2.9
Wt	NA								
Prog.BW	NA								
WR	NA								
YR	NA								
Wean Pct.	NA%								
Cow Eff.	NA								
		Marb			REA			Bfat	
		BWt	WWt	WR	ADG	YWt	YR	Scr.	Fr.
		86	595	101	3.36	1133	101	NA	5.5

★★★★★ for Low Maintenance, Rib-eye area, Calving Ease, Stayability. **Selling ½ Interest & Full Possession.**

18 BECKTON JET W142 E2

1-A 100% # 1332122 Tattoo: BKT9 W142

Birth: 3-9-09

TR Julian LT151
BECKTON JET L P491
 Ref. J-2

Beckton Julian GG B571
 MS Geometric 917

Beckton Lancer TS D390
 Beckton Minerva F495 CH

Beckton Epic KJ J722
BKT PINE MARIE P351 EP
 BKT Pine Marie L002 HR

Beckton Epic K F075
 Beckton Lana F891 JL

Beckton Herald FV J537
 BKT Pine Marie J931 RN

DAM		Calv.Ease	BW	WW	YW	Milk	HPG	Stay	Maint.En.
Age	5	11	-2.7	28	60	17	9	13	1.4
Wt	1095								
Prog.BW	76								
WR	112								
YR	112								
Wean Pct.	57%								
Cow Eff.	121								
		Marb			REA			Bfat	
		BWt	WWt	WR	ADG	YWt	YR	Scr.	Fr.
		78	628	105	4.19	1205	113	41	5.5

★★★★★ for Low Maintenance, Gainability, Rib-eye area, Superior Cow, High Cow Efficiency, Calving Ease, Stayability. **Selling ½ Interest & Full Possession.**

19 BECKTON EPIC W298 N4

1-A 100% # 1332051 Tattoo: BKT9 W298

Birth: 3-19-09

Beckton Epic K F075
Beckton Epic D404
Beckton Belga D483 KR

BECKTON EPIC R350 K
Ref. E-2
Beckton Larkaba E042 CD
Beckton Cody C401
Beckton Larkaba C317 CL

Beckton Neptune R2 K065
Beckton Neptune RR B284
Beckton Lana C735 TP

BECKTON RUTH M047 NP
Beckton Ruth K464 JL
Beckton Julian GG B571
Beckton Ruth A905 SG

DAM		Calv.Ease	BW	WW	YW	Milk	HPG	Stay	Maint.En.
Age	7	9	-0.9	34	71	18	10	13	-4.8
Wt	1000								
Prog.BW	79								
WR	109		Marb +.09		REA +.02		Bfat +.01		
YR	107								
Wean Pct.	66%	BWt	WWt	WR	ADG	YWt	YR	Scr.	Fr.
Cow Eff.	139	89	661	111	4.05	1220	115	38	5.5

★★★★★ for Low Maintenance, Growth, Gainability, Superior Cow, High Cow Efficiency, Calving Ease, Stayability. **Selling ½ Interest & Full Possession.**

22 BECKTON NEBULA W152 W3

1-A 100% # 1331719 Tattoo: BSF9 W152

Birth: 3-10-09

Beckton Nebula M045
Beckton Neptune R2 K065
Beckton Belga K285 JL

BECKTON NEBULA G S237
Ref. N-6
Beckton Lakme LA06 JL
Beckton Julian GG B571
Beckton Lakme B370 HV

Beckton Warrior T1 H281
Beckton Warrior TC E801
Beckton Minerva B609 RN

BECKTON LANA N473 WR
Beckton Lana K237 EP
Beckton Epic D404
Beckton Lana CB29 JL

DAM		Calv.Ease	BW	WW	YW	Milk	HPG	Stay	Maint.En.
Age	6	12	-1.6	28	68	8	13	12	-5.9
Wt	1085								
Prog.BW	72								
WR	102		Marb +.02		REA +.13		Bfat +.01		
YR	108								
Wean Pct.	55%	BWt	WWt	WR	ADG	YWt	YR	Scr.	Fr.
Cow Eff.	116	85	596	100	3.92	1137	107	36	5.5

★★★★★ for Low Maintenance, Growth, Rib-eye area, Calving Ease. **Selling ½ Interest & Full Possession.**

20 BECKTON EPIC W302 L5

1-A 100% # 1332093 Tattoo: BKT9 W302

Birth: 3-19-09

Beckton Epic KJ J722
Beckton Epic K F075
Beckton Lana F891 JL

BECKTON EPIC K4 N795
Ref. E-1
Beckton Sierra J789 EP
Beckton Epic D404
Beckton Sierra C157 CL

Beckton Lancer TH K417
Beckton Lancer T A664
Beckton Angel G356 HR

BECKTON SIERRA N403 LN
Beckton Sierra J659 DM
Beckton Dominor ZR G223
Beckton Sierra G671 DM

DAM		Calv.Ease	BW	WW	YW	Milk	HPG	Stay	Maint.En.
Age	6	7	0.1	36	79	17	5	12	4.5
Wt	1110								
Prog.BW	79								
WR	111		Marb +.19		REA +.09		Bfat +.00		
YR	109								
Wean Pct.	61%	BWt	WWt	WR	ADG	YWt	YR	Scr.	Fr.
Cow Eff.	129	82	677	114	3.47	1144	108	33	5.5

★★★★★ for Growth, Marbling, Superior Cow, High Cow Efficiency, Calving Ease. **Selling ½ Interest & Full Possession.**



21 BECKTON EPIC W282

1-A 100% # 1331698 Tattoo: BSF9 W282

Birth: 3-18-09

Beckton Epic KJ J722
Beckton Epic K F075
Beckton Lana F891 JL

BECKTON EPIC K4 N795
Ref. E-1
Beckton Sierra J789 EP
Beckton Epic D404
Beckton Sierra C157 CL

Andras Pure Gold 132
Badlands Mr Beef 805
JHL D5803

BECKTON ENCINO N076 PG
Beckton Encino L922 CH
Beckton Champ R3 H338
Beckton Encino G341 NP

DAM		Calv.Ease	BW	WW	YW	Milk	HPG	Stay	Maint.En.
Age	6	9	-2.6	36	79	17	5	10	5.1
Wt	1210								
Prog.BW	73								
WR	111		Marb +.08		REA -.02		Bfat +.00		
YR	110								
Wean Pct.	56%	BWt	WWt	WR	ADG	YWt	YR	Scr.	Fr.
Cow Eff.	118	74	677	117	3.56	1203	112	34	5.5

★★★★★ for Growth, Superior Cow, High Cow Efficiency, Calving Ease.

23 BECKTON CLIFFTOP W446 E3

1-A 100% # 1331690 Tattoo: BSF9 W446

Birth: 3-26-09

Beckton Clifftop T C075
BJR Topper 5241
Beckton Barmaid A761 TR

BKT CLIFFTOP TP R288
Ref. B-1
Beckton Christy K209 CO
Beckton Copper JT G095
Beckton Christy A111 VQ

Beckton Epic K1 K863
Beckton Epic KN H110
Beckton Rose H019 SC

BECKTON EOLA M663 EP
Beckton Eola K178 EP
Beckton Epic KN H110
Beckton Eola H481 HD

DAM		Calv.Ease	BW	WW	YW	Milk	HPG	Stay	Maint.En.
Age	7	11	-3.1	26	53	20	9	14	-5.7
Wt	1045								
Prog.BW	71								
WR	105		Marb +.08		REA +.17		Bfat +.01		
YR	104								
Wean Pct.	62%	BWt	WWt	WR	ADG	YWt	YR	Scr.	Fr.
Cow Eff.	130	77	645	111	3.24	1139	106	38	5.5

★★★★★ for Low Maintenance, Rib-eye area, Superior Cow, High Cow Efficiency, Calving Ease, Stayability.

• Bulls •



26 **BECKTON NEBULA W616 J4**

1-A 100% # 1332145 Tattoo: BKT9 W616

Birth: 4-5-09
 Beckton Nebula P P707
BECKTON NEBULA PJ S543
 Ref. N-8 Beckton Lana P685 JO
 Beckton Nebula M045
 Beckton Lana M809 EP
 Beckton Julio L233
 Beckton Lana E083 CD
 Beckton Justice G302
 Beckton Lana J278 CH
 Beckton Epic KJ J722
 Beckton Barmaid H225 HD

DAM		Calv.Ease	BW	WW	YW	Milk	HPG	Stay	Maint.En.
Age	5	14	-3.1	36	74	14	9	14	-6.7
Wt	905	Marb +0.08		REA +0.18		Bfat +0.01			
Prog.BW	63	BWt	WWt	WR	ADG	YWt	YR	Scr.	Fr.
WR	103	74	669	113	4.01	1149	108	38	5.5
YR	100								
Wean Pct.	74%								
Cow Eff.	156								

★★★★★ for Low Maintenance, Growth, Gainability, Rib-eye area, High Cow Efficiency, Calving Ease, Stayability. **Selling ½ Interest & Full Possession.**

24 **BECKTON NEBULA W317 E3**

1-A 100% # 1332068 Tattoo: BKT9 W317

Birth: 3-20-09
 Beckton Nebula M045
BECKTON NEBULA J R475
 Ref. N-5 Beckton Larkeisa M138 JC
 Beckton Neptune R2 K065
 Beckton Belga K285 JL
 Beckton Justice G302
 Bkt Larkeisa G448 CT
 Beckton Epic K F075
 Beckton Lana F891 JL
BECKTON MINERVA M651 EP
 Beckton Epic KJ J722
 Beckton Minerva H394 CL
 Beckton Clipper KR C290
 Beckton Minerva C619 NP

DAM		Calv.Ease	BW	WW	YW	Milk	HPG	Stay	Maint.En.
Age	7	12	-2.6	24	60	7	9	12	-9.5
Wt	1180	Marb +0.13		REA +0.13		Bfat +0.00			
Prog.BW	64	BWt	WWt	WR	ADG	YWt	YR	Scr.	Fr.
WR	93	82	577	99	4.05	1139	106	40	5.5
YR	107								
Wean Pct.	49%								
Cow Eff.	103								

★★★★★ for Low Maintenance, Gainability, Marbling, Rib-eye area, Calving Ease. **Selling ½ Interest & Full Possession.**

27 **BECKTON LOKI W430 L4**

1-A 100% # 1332126 Tattoo: BKT9 W430

Birth: 3-25-09
 Beckton Loki C M740
BECKTON LOKI CL S284
 Ref. L-2 Beckton Lakme J460 LT
 Beckton Loki F251
 BKT Larkeisa J051 CK
 Beckton Latigo G714
 Beckton Lakme G128 HD
 Beckton Lancer TZ D525
 Beckton Vernice D121 VG
BKT PINE MARIE P475 LN
 Beckton Lancer T4 J536
 Bkt Pine Marie LC30 CD
 Beckton Cody V E023
 Bkt Pine Marie D764 HD

DAM		Calv.Ease	BW	WW	YW	Milk	HPG	Stay	Maint.En.
Age	5	13	-3.5	30	67	15	9	13	3.1
Wt	1230	Marb +0.08		REA -0.04		Bfat -0.01			
Prog.BW	64	BWt	WWt	WR	ADG	YWt	YR	Scr.	Fr.
WR	99	76	652	109	4.14	1163	109	41	5.5
YR	101								
Wean Pct.	53%								
Cow Eff.	112								

★★★★★ for Low Maintenance, Growth, Gainability, Calving Ease, Stayability.

25 **BECKTON NEBULA W270 C4**

1-A 100% # 1331748 Tattoo: BSF9 W270

Birth: 3-17-09
 Beckton Nebula P P707
BECKTON NEBULA PJ S543
 Ref. N-8 Beckton Lana P685 JO
 Beckton Nebula M045
 Beckton Lana M809 EP
 Beckton Julio L233
 Beckton Lana E083 CD
 Beckton Champ RH F275
 Beckton Lana F138 LN
BECKTON CHRISTY P333 CH
 Beckton Champ R1 H024
 Beckton Christy K209 CO
 Beckton Copper JT G095
 Beckton Christy A111 VQ

DAM		Calv.Ease	BW	WW	YW	Milk	HPG	Stay	Maint.En.
Age	5	13	-3.8	33	65	18	9	14	-6.0
Wt	900	Marb +0.02		REA +0.21		Bfat +0.00			
Prog.BW	54	BWt	WWt	WR	ADG	YWt	YR	Scr.	Fr.
WR	98	78	646	111	3.51	1134	106	35	5.5
YR	100								
Wean Pct.	72%								
Cow Eff.	151								

★★★★★ for Low Maintenance, Growth, Rib-eye area, High Cow Efficiency, Calving Ease, Stayability. **Selling ½ Interest & Full Possession.**

28 **BECKTON NEBULA W320 J4**

1-A 100% # 1332079 Tattoo: BKT9 W320

Birth: 3-20-09
 Beckton Nebula P P707
BECKTON NEBULA PJ S543
 Ref. N-8 Beckton Lana P685 JO
 Beckton Nebula M045
 Beckton Lana M809 EP
 Beckton Julio L233
 Beckton Lana E083 CD
 Beckton Julian G1 J526
 Beckton Barona J591 EP
BECKTON SUSAN N023 JE
 Beckton Jules L429
 Beckton Susan L258 LR
 MRM Lancer 916
 Beckton Susan F315 TP

DAM		Calv.Ease	BW	WW	YW	Milk	HPG	Stay	Maint.En.
Age	6	15	-5.3	31	55	18	8	15	-3.5
Wt	1000	Marb +0.07		REA +0.15		Bfat +0.01			
Prog.BW	64	BWt	WWt	WR	ADG	YWt	YR	Scr.	Fr.
WR	108	71	669	113	2.88	1069	101	32	5.5
YR	100								
Wean Pct.	67%								
Cow Eff.	141								

★★★★★ for Low Maintenance, Rib-eye area, High Cow Efficiency, Calving Ease, Stayability.

• Bulls •

29 **BSF HASTEN W231 N3**
1-B 99% # 1331733 Tattoo: BSF9 W231

Birth: 3-15-09
 Beckton Hasten P292
BECKTON HASTEN H S462
 Ref. H-2
 Beckton Lakme G128 HD
 Beckton Hustler C2 L079
 Beckton Sheba L644 CH
 Beckton Hadrian FC E166
 Beckton Lakme E373 CL
 Beckton Neptune R2 K065
 Beckton Belga K285 JL
 Beckton Epic K F075
 BSF Regus H098
 Beckton Nebula M045
BSF NEBULANN P046
 BSF Regus M717 EP

DAM		Calv.Ease	BW	WW	YW	Milk	HPG	Stay	Maint.En.
Age	5	16	-6.6	27	60	18	11	13	-4.1
Wt	965								
Prog.BW	60								
WR	98			Marb +.02	REA +.15			Bfat +.00	
YR	102								
Wean Pct.	62%	BWt	WWt	WR	ADG	YWt	YR	Scr.	Fr.
Cow Eff.	131	62	601	101	4.28	1139	107	40	5.0

★★★★★ for Low Maintenance, Gainability, Rib-eye area, High Cow Efficiency, Calving Ease, Stayability.



31 **BSF ROMAN W725**
1-B 99% # 1332027 Tattoo: BKT9 W725

Birth: 4-16-09
 TR Romeo NT379
BECKTON ROMAN J S158
 Ref. J-6
 Beckton Belga K285 JL
 Buffalo Creek Romeo L081
 Buf Crk Lass L420
 Beckton Julian GG B571
 Beckton Belga G493 HR
 Beckton Vegas P D462
 Beckton Lakme D399 KR
 Beckton Nomad V 9871
 BSF Regus D019
 Beckton Vegas PK F485
BSF REGUS K542 VG
 BSF Regus G483

DAM		Calv.Ease	BW	WW	YW	Milk	HPG	Stay	Maint.En.
Age	NA	9	-0.4	37	66	22	10	13	-2.1
Wt	1105								
Prog.BW	74								
WR	114			Marb -.08	REA +.11			Bfat -.01	
YR	110								
Wean Pct.	64%	BWt	WWt	WR	ADG	YWt	YR	Scr.	Fr.
Cow Eff.	135	77	708	132	3.56	1207	117	35	5.5

★★★★★ for Low Maintenance, Growth, Superior Cow, High Cow Efficiency, Calving Ease, Stayability.

32 **BSF CLIFFTOP W222 E3**
1-B 99% # 1331703 Tattoo: BSF9 W222

Birth: 3-15-09
 Beckton Clifftop T C075
BKT CLIFFTOP TP R288
 Ref. B-1
 Beckton Christy K209 CO
 Beckton Epic KJ J722
BSF ERICA N159 EP
 BSF Red G006
 BJR Topper 5241
 Beckton Barmaid A761 TR
 Beckton Copper JT G095
 Beckton Christy A111 VQ
 Beckton Epic K F075
 Beckton Lana F891 JL
 Beckton Julius E349
 BSF Regus E305

DAM		Calv.Ease	BW	WW	YW	Milk	HPG	Stay	Maint.En.
Age	6	12	-4.2	25	55	19	7	14	-3.4
Wt	1160								
Prog.BW	73								
WR	109			Marb +.08	REA +.03			Bfat +.01	
YR	111								
Wean Pct.	59%	BWt	WWt	WR	ADG	YWt	YR	Scr.	Fr.
Cow Eff.	125	68	688	116	3.29	1132	107	42	5.0

★★★★★ for Low Maintenance, Superior Cow, High Cow Efficiency, Calving Ease, Stayability.

30 **BSF NEBULA W447 N4**
1-B 99% # 1331709 Tattoo: BSF9 W447

Birth: 3-26-09
 Beckton Nebula P P707
BECKTON NEBULA PJ S543
 Ref. N-8
 Beckton Lana P685 JO
 Beckton Nebula M045
 Beckton Lana M809 EP
 Beckton Julio L233
 Beckton Lana E083 CD
 Beckton Neptune RR B284
 Beckton Lana C735 TP
 Red Angus multiple sire
 BSF Regus B655
 Beckton Neptune R2 K065
BSF NEENA N333 NP
 BSF Brockle G498

DAM		Calv.Ease	BW	WW	YW	Milk	HPG	Stay	Maint.En.
Age	6	11	-2.8	36	73	18	9	11	-3.2
Wt	1055								
Prog.BW	72								
WR	110			Marb +.08	REA +.05			Bfat +.01	
YR	107								
Wean Pct.	62%	BWt	WWt	WR	ADG	YWt	YR	Scr.	Fr.
Cow Eff.	131	81	655	110	3.87	1180	111	35	5.5

★★★★★ for Low Maintenance, Growth, Superior Cow, High Cow Efficiency, Calving Ease.

33 **BSF NEBULA W442 H3**
1-B 99% # 1331792 Tattoo: BSF9 W442

Birth: 3-25-09
 Beckton Nebula M045
BECKTON NEBULA J R475
 Ref. N-5
 Beckton Larkeisa M138 JC
 Beckton Neptune R2 K065
 Beckton Belga K285 JL
 Beckton Justice G302
 Bkt Larkeisa G448 CT
 Beckton Hustler CN J102
 Beckton Barmaid J012 CO
 Beckton Lancer TL G626
 BSF Regus G673
 Beckton Hustler C2 L079
BSF HUSTELLE R234 HU
 BSF Regus L774 LN

DAM		Calv.Ease	BW	WW	YW	Milk	HPG	Stay	Maint.En.
Age	4	10	-1.3	34	70	8	10	14	-6.6
Wt	1090								
Prog.BW	79								
WR	105			Marb +.15	REA +.21			Bfat -.01	
YR	112								
Wean Pct.	56%	BWt	WWt	WR	ADG	YWt	YR	Scr.	Fr.
Cow Eff.	117	83	627	108	3.78	1172	109	39	6.0

★★★★★ for Low Maintenance, Growth, Marbling, Rib-eye area, Superior Cow, High Cow Efficiency, Calving Ease, Stayability.

• Bulls •



34 BSF EMPEROR W004 C3
1-B 99% # 1331929 Tattoo: BSF9 W004

Birth: 2-14-09
 Beckton Emperor R100
BECKTON EMPEROR T641 E2
 Ref. E-6
 Beckton Vernice R416 EP
 Beckton Epic K4 N795
 Beckton Tamara N180 JO
 Beckton Epic K3 M606
 Beckton Vernice K482 HD
 Beckton Clifftop T C075
 Beckton Christy K209 CO
 Beckton Laser N602
 BSF Buffie N648 CO
 BKT Clifftop TP R288
 BSF Buffie R316 LS

DAM		Calv.Ease	BW	WW	YW	Milk	HPG	Stay	Maint.En.
Age	2	8	-0.9	33	71	17	6	16	3.3
Wt	855								
Prog.BW	71								
WR	117								
YR	110								
Wean Pct.	66%								
Cow Eff.	139								
		Marb	+0.07		REA	+0.17		Bfat	+0.00
		BWt	WWt	WR	ADG	YWt	YR	Scr.	Fr.
		71	625	117	3.74	1092	110	34	5.5

★★★★★ for Low Maintenance, Growth, Rib-eye area, Superior Cow, High Cow Efficiency, Calving Ease, Stayability.

35 BSF WARRIOR W225 N4
1-B 99% # 1331671 Tattoo: BSF9 W225

Birth: 3-15-09
 Beckton Warrior CL M686
BECKTON WARRIOR C1 S337
 Ref. W-2
 Beckton Christy K101 CD
 Beckton Warrior C C355
 Beckton Christy J223 LN
 Beckton Cody V E023
 Beckton Christy C306 JL
 Beckton Neptune RR B284
 Beckton Lana C735 TP
 Beckton Neptune R2 K065
BSF REGUS M006 NP
 BSF Regus K326 WH
 Beckton Washaki G272
 BSF Regus E628

DAM		Calv.Ease	BW	WW	YW	Milk	HPG	Stay	Maint.En.
Age	7	12	-2.5	32	65	15	11	12	-0.7
Wt	NA								
Prog.BW	75								
WR	103								
YR	107								
Wean Pct.	NA%								
Cow Eff.	NA								
		Marb	-0.01		REA	+0.17		Bfat	-0.01
		BWt	WWt	WR	ADG	YWt	YR	Scr.	Fr.
		80	635	109	4.51	1127	105	43	5.5

★★★★★ for Low Maintenance, Growth, Gainability, Rib-eye area, Calving Ease.

37 BSF NEBULA W327 J4
1-B 99% # 1331853 Tattoo: BSF9 W327

Birth: 3-20-09
 Beckton Nebula P P707
BECKTON NEBULA PJ S543
 Ref. N-8
 Beckton Lana P685 JO
 Beckton Nebula M045
 Beckton Lana M809 EP
 Beckton Julio L233
 Beckton Lana E083 CD
 Beckton Jet L P491
BSF JULIANNE S127 JT
 BSF Julianne P881
 TR Julian LT151
 Beckton Minerva L278 LN
 Beckton Julian G1 J526
 BSF Regus J378

DAM		Calv.Ease	BW	WW	YW	Milk	HPG	Stay	Maint.En.
Age	3	17	-6.4	30	63	17	9	16	-0.8
Wt	920								
Prog.BW	62								
WR	108								
YR	103								
Wean Pct.	60%								
Cow Eff.	127								
		Marb	+0.21		REA	+0.21		Bfat	+0.01
		BWt	WWt	WR	ADG	YWt	YR	Scr.	Fr.
		59	596	108	3.69	1070	103	35	5.5

★★★★★ for Low Maintenance, Marbling, Rib-eye area, Superior Cow, High Cow Efficiency, Calving Ease, Stayability.

36 BSF DOMINIQUE W112 D
1-B 99% # 1331677 Tattoo: BSF9 W112

Birth: 3-6-09
 Beckton Dominor ZC M919
BECKTON DOMINOR Z1 R610
 Ref. D-1
 Beckton Sierra K557 LO
 Beckton Dominor Z E401
 Beckton Barmaid J012 CO
 Beckton Loki F251
 Beckton Sierra C157 CL
 Beckton Lancer TN F726
 Beckton Belga F657 TP
 Beckton Lancer T1 H080
BSF REGUS M209 LN
 BSF Regus D305
 Beckton Hadrian A100
 BSF Regus A338

DAM		Calv.Ease	BW	WW	YW	Milk	HPG	Stay	Maint.En.
Age	7	16	-5.3	23	57	14	8	14	0.8
Wt	1180								
Prog.BW	64								
WR	95								
YR	101								
Wean Pct.	49%								
Cow Eff.	102								
		Marb	+0.18		REA	+0.06		Bfat	+0.01
		BWt	WWt	WR	ADG	YWt	YR	Scr.	Fr.
		60	572	96	4.51	1092	103	37	5.5

★★★★★ for Low Maintenance, Gainability, Marbling, Calving Ease, Stayability.

38 BSF NEBULA W131 N4
1-B 99% # 1331981 Tattoo: BSF9 W131

Birth: 3-8-09
 Beckton Nebula L P093
BECKTON NEBULA T252 L3
 Ref. N-10
 Beckton Vernice L382 LN
 Beckton Nebula M045
 Beckton Marta M021 LN
 Beckton Lancer TZ D525
 Beckton Vernice G373 WR
 Beckton Nebula L P093
BSF NEBULANN T807 NB
 BSF Regus M902 CR
 Beckton Nebula M045
 Beckton Marta M021 LN
 Beckton Colter HW J766
 BSF Red H467

DAM		Calv.Ease	BW	WW	YW	Milk	HPG	Stay	Maint.En.
Age	2	13	-3.7	31	63	11	9	14	-4.7
Wt	880								
Prog.BW	62								
WR	104								
YR	104								
Wean Pct.	57%								
Cow Eff.	119								
		Marb	+0.07		REA	+0.20		Bfat	-0.01
		BWt	WWt	WR	ADG	YWt	YR	Scr.	Fr.
		62	557	104	3.69	1028	104	34	5.5

★★★★★ for Low Maintenance, Rib-eye area, Superior Cow, High Cow Efficiency, Calving Ease, Stayability.

• Bulls •

39 BSF NEBULA W828 L3

1-B 99% # 1331666 Tattoo: BSF9 W828

Birth: 4-26-09

Beckton Nebula M045
 Beckton Neptune R2 K065
 Beckton Belga K285 JL

BECKTON NEBULA L P093
 Ref. N-2
 Beckton Marta M021 LN
 Beckton Lancer TA K644
 Beckton Marta K254 LN

Beckton Lancer TL G626
 Beckton Lancer T A664
 Beckton Fayette C110 LN

BSF RED ROAN L823 LN
 Beckton Caesar M D023
 BSF Regus D006

DAM		Calv.Ease	BW	WW	YW	Milk	HPG	Stay	Maint.En.
Age	8	13	-2.7	31	64	9	8	15	-3.5
Wt	1150	Marb +.10		REA +.19		Bfat -.01			
Prog.BW	68	BWt	WWt	WR	ADG	YWt	YR	Scr.	Fr.
WR	103	75	622	105	3.83	1137	107	34	5.5
YR	101								
Wean Pct.	54%								
Cow Eff.	114								

★★★★★ for Low Maintenance, Growth, Rib-eye area, Calving Ease, Stayability.

42 BECKTON NEBULA W236 J3

1-A 100% # 1331720 Tattoo: BSF9 W236

Birth: 3-16-09

Beckton Nebula M045
 Beckton Neptune R2 K065
 Beckton Belga K285 JL

BECKTON NEBULA G S237
 Ref. N-6
 Beckton Lakme LA06 JL
 Beckton Julian GG B571
 Beckton Lakme B370 HV

Beckton Julian G1 J526
 Beckton Julian GG B571
 Beckton Annie F743 LN

BECKTON ROSE N495 JL
 Beckton Hadrian F C486
 Beckton Rose D731 CB

DAM		Calv.Ease	BW	WW	YW	Milk	HPG	Stay	Maint.En.
Age	6	17	-4.4	26	52	10	12	14	-9.3
Wt	1025	Marb +.05		REA +.07		Bfat +.00			
Prog.BW	68	BWt	WWt	WR	ADG	YWt	YR	Scr.	Fr.
WR	99	69	626	105	3.65	1125	105	38	5.0
YR	98								
Wean Pct.	61%								
Cow Eff.	129								

★★★★★ for Low Maintenance, High Cow Efficiency, Calving Ease, Stayability.

40 BSF NEBULA W207 H3

1-B 99% # 1331768 Tattoo: BSF9 W207

Birth: 3-14-09

Beckton Nebula M045
 Beckton Neptune R2 K065
 Beckton Belga K285 JL

BECKTON NEBULA J R475
 Ref. N-5
 Beckton Larkeisa M138 JC
 Beckton Justice G302
 Bkt Larkeisa G448 CT

Beckton Hustler CN J102
 Beckton Hustler C G407
 Beckton Belga G355 NP

BSF HUSTLE P748
 WF Regus H107
 BSF Casper F784
 Bkt Sunflower F257 CS

DAM		Calv.Ease	BW	WW	YW	Milk	HPG	Stay	Maint.En.
Age	5	10	-0.8	32	65	9	13	12	-8.1
Wt	1085	Marb +.04		REA +.31		Bfat -.01			
Prog.BW	73	BWt	WWt	WR	ADG	YWt	YR	Scr.	Fr.
WR	104	94	589	99	3.60	1089	103	37	5.5
YR	103								
Wean Pct.	54%								
Cow Eff.	114								

★★★★★ for Low Maintenance, Rib-eye area, Calving Ease.

43 BECKTON EPIC W315 H4

1-A 100% # 1331746 Tattoo: BSF9 W315

Birth: 3-20-09

Beckton Epic K F075
 Beckton Epic D404
 Beckton Belga D483 KR

BECKTON EPIC R350 K
 Ref. E-2
 Beckton Larkaba E042 CD
 Beckton Cody C401
 Beckton Larkaba C317 CL

Beckton Herald FV J537
 Beckton Herald F FA20
 Beckton Kuruba F588 VG

BECKTON BARMAID P323 HR
 Beckton Copper JT G095
 Beckton Barmaid G565 LN

DAM		Calv.Ease	BW	WW	YW	Milk	HPG	Stay	Maint.En.
Age	5	8	-0.7	35	62	21	9	12	-0.4
Wt	1065	Marb +.13		REA +.02		Bfat +.02			
Prog.BW	73	BWt	WWt	WR	ADG	YWt	YR	Scr.	Fr.
WR	111	84	677	117	3.83	1142	107	36	5.5
YR	101								
Wean Pct.	64%								
Cow Eff.	134								

★★★★★ for Low Maintenance, Growth, Marbling, High Cow Efficiency, Calving Ease.

41 BECKTON LOKI W665 N4

1-A 100% # 1331767 Tattoo: BSF9 W665

Birth: 4-9-09

Beckton Loki C M740
 Beckton Loki F251
 BKT Larkeisa J051 CK

BECKTON LOKI CL S284
 Ref. L-2
 Beckton Lakme J460 LT
 Beckton Latigo G714
 Beckton Lakme G128 HD

Beckton Neptune R2 K065
 Beckton Neptune RR B284
 Beckton Lana C735 TP

BECKTON COCA P713 NP
 Beckton Coca H051 CH
 Beckton Champ RH F275
 Beckton Coca F048 LN

DAM		Calv.Ease	BW	WW	YW	Milk	HPG	Stay	Maint.En.
Age	5	12	-3.8	31	69	19	7	12	-2.8
Wt	1100	Marb +.10		REA -.06		Bfat -.01			
Prog.BW	77	BWt	WWt	WR	ADG	YWt	YR	Scr.	Fr.
WR	112	75	678	114	3.56	1203	113	39	5.5
YR	113								
Wean Pct.	62%								
Cow Eff.	130								

★★★★★ for Low Maintenance, Growth, Superior Cow, High Cow Efficiency, Calving Ease.



• Bulls •

44 BECKTON NEBULA W630 L3
1-A 100% # 1332180 Tattoo: BKT9 W630

Birth: 4-6-09
 Beckton Nebula M045
BECKTON NEBULA J R475
 Ref. N-5
 Beckton Larkeisa M138 JC
 Beckton Neptune R2 K065
 Beckton Belga K285 JL
 Beckton Justice G302
 Bkt Larkeisa G448 CT
 Beckton Lancer TA K644
 BKT Larkeisa H232 SC
BECKTON LANA R334 LN
 Beckton Lancer T9 N586
 Beckton Warrior T2 J333
 Beckton Lana N862 WR
 Beckton Lana H329 HD

DAM		Calv.Ease	BW	WW	YW	Milk	HPG	Stay	Maint.En.
Age	4	12	-1.9	33	68	9	11	11	-8.3
Wt	1080	Marb +.11		REA +.22		Bfat -.01			
Prog.BW	72	BWt	WWt	WR	ADG	YWt	YR	Scr.	Fr.
WR	111	81	681	117	3.69	1198	112	36	5.5
YR	111								
Wean Pct.	61%								
Cow Eff.	129								

★★★★★ for Low Maintenance, Growth, Marbling, Rib-eye area, Superior Cow, High Cow Efficiency, Calving Ease. **Selling ½ Interest & Full Possession.**

47 BECKTON NEBULA W469 C4
1-A 100% # 1332043 Tattoo: BKT9 W469

Birth: 3-27-09
 Beckton Nebula E P084
BECKTON NEBULA EN S347
 Ref. N-7
 Beckton Eola P530 NB
 Beckton Nebula M045
 BKT Pine Marie M119 EP
 Beckton Nebula M045
 Beckton Eola M663 EP
 Beckton Clipper L H158
 Beckton Larkabel C742 CF
BECKTON FIREFLY L599 CL
 Beckton Clipper L H158
 Beckton Firefly G009 CT
 Beckton Clifftop TC E081
 Beckton Firefly E920 MB

DAM		Calv.Ease	BW	WW	YW	Milk	HPG	Stay	Maint.En.
Age	8	12	-2.4	27	50	11	11	14	-10.7
Wt	1025	Marb +.09		REA -.21		Bfat -.01			
Prog.BW	76	BWt	WWt	WR	ADG	YWt	YR	Scr.	Fr.
WR	100	86	632	106	3.47	1097	103	34	5.5
YR	98								
Wean Pct.	62%								
Cow Eff.	130								

★★★★★ for Low Maintenance, High Cow Efficiency, Calving Ease, Stayability.

45 BECKTON WARRIOR W574 L4
1-A 100% # 1331685 Tattoo: BSF9 W574

Birth: 4-2-09
 Beckton Warrior CL M686
BECKTON WARRIOR C1 S337
 Ref. W-2
 Beckton Christy K101 CD
 Beckton Warrior C C355
 Beckton Christy J223 LN
 Beckton Cody V E023
 Beckton Christy C306 JL
 Beckton Lancer TZ D525
 Bkt Pine Marie D126 JL
BECKTON LANA M597 LO
 Beckton Loki F251
 Beckton Clifftop T C075
 Beckton Lana J131 CT
 Beckton Lana F028 VG

DAM		Calv.Ease	BW	WW	YW	Milk	HPG	Stay	Maint.En.
Age	7	15	-3.4	28	59	15	8	14	-0.8
Wt	985	Marb +.14		REA +.07		Bfat -.01			
Prog.BW	66	BWt	WWt	WR	ADG	YWt	YR	Scr.	Fr.
WR	102	73	632	109	4.14	1151	107	38	5.5
YR	101								
Wean Pct.	64%								
Cow Eff.	135								

★★★★★ for Low Maintenance, Gainability, Marbling, High Cow Efficiency, Calving Ease, Stayability.

48 BECKTON NEBULA W230 N3
1-A 100% # 1332216 Tattoo: BKT9 W230

Birth: 3-15-09
 Beckton Nebula M045
BECKTON NEBULA L P093
 Ref. N-2
 Beckton Marta M021 LN
 Beckton Nebula M045
 Beckton Neptune R2 K065
 Beckton Belga K285 JL
BECKTON TAMARA R801 NB
 Beckton Nebula M045
 Beckton Tamara HA54 LN
 Beckton Lancer TA K644
 Beckton Marta K254 LN
 Beckton Neptune R2 K065
 Beckton Belga K285 JL
 Beckton Lancer TS D390
 Beckton Tamara D383 JV

DAM		Calv.Ease	BW	WW	YW	Milk	HPG	Stay	Maint.En.
Age	4	13	-3.0	31	62	5	13	14	-3.7
Wt	1055	Marb +.02		REA +.24		Bfat -.01			
Prog.BW	68	BWt	WWt	WR	ADG	YWt	YR	Scr.	Fr.
WR	103	73	583	98	4.28	1101	104	41	5.5
YR	99								
Wean Pct.	53%								
Cow Eff.	112								

★★★★★ for Low Maintenance, Gainability, Rib-eye area, Calving Ease, Stayability.

46 BECKTON NEBULA W300 L4
1-A 100% # 1332130 Tattoo: BKT9 W300

Birth: 3-19-09
 Beckton Nebula P P707
BECKTON NEBULA PJ S543
 Ref. N-8
 Beckton Lana P685 JO
 Beckton Nebula M045
 Beckton Lana M809 EP
 Beckton Julio L233
 Beckton Lana E083 CD
 Beckton Lancer T5 L095
 Beckton Lancer F442 T
 Beckton Belga J293 HR
BECKTON SIERRA P531 LN
 Beckton Sierra L215 LN
 Beckton Lancer T3 J396
 Beckton Sierra J482 CD

DAM		Calv.Ease	BW	WW	YW	Milk	HPG	Stay	Maint.En.
Age	5	14	-4.2	31	62	16	7	13	-3.7
Wt	990	Marb +.07		REA +.06		Bfat +.00			
Prog.BW	61	BWt	WWt	WR	ADG	YWt	YR	Scr.	Fr.
WR	104	72	618	106	3.69	1111	104	35	5.0
YR	104								
Wean Pct.	62%								
Cow Eff.	131								

★★★★★ for Low Maintenance, Superior Cow, High Cow Efficiency, Calving Ease, Stayability.

49 BECKTON NEBULA W260 J3
1-A 100% # 1332195 Tattoo: BKT9 W260

Birth: 3-17-09
 Beckton Nebula M045
BECKTON NEBULA L P093
 Ref. N-2
 Beckton Marta M021 LN
 Beckton Nebula M045
 Beckton Neptune R2 K065
 Beckton Belga K285 JL
 Beckton Lancer TA K644
 Beckton Marta K254 LN
 Beckton Justice G302
 Beckton Julian GG B571
 Bkt Vernice 9733 PC
BECKTON LANA R504 JC
 Beckton Lana M809 EP
 Beckton Epic K1 K863
 Beckton Lana K253 DM

DAM		Calv.Ease	BW	WW	YW	Milk	HPG	Stay	Maint.En.
Age	4	15	-4.7	29	60	7	13	13	-4.2
Wt	1055	Marb +.19		REA +.11		Bfat +.00			
Prog.BW	65	BWt	WWt	WR	ADG	YWt	YR	Scr.	Fr.
WR	97	64	588	99	3.65	1083	102	37	5.5
YR	102								
Wean Pct.	54%								
Cow Eff.	113								

★★★★★ for Low Maintenance, Marbling, Calving Ease, Stayability.

• Bulls •

50 BECKTON LOKI W412 W4
1-A 100% # 1331827 Tattoo: BSF9 W412

Birth: 3-24-09
 Beckton Loki C M740
BECKTON LOKI CL S284
 Ref. L-2
 Beckton Lakme J460 LT
 Beckton Loki F251
 BKT Larkeisa J051 CK
 Beckton Latigo G714
 Beckton Lakme G128 HD
 Beckton Warrior C C355
 Beckton Christy J223 LN
BECKTON INDIGO R745 WR
 Beckton Warrior CL M686
 Beckton Indigo M514 CH
 Beckton Champ R3 H338
 Beckton Indigo F587 LN

DAM		Calv.Ease	BW	WW	YW	Milk	HPG	Stay	Maint.En.
Age	4	14	-4.5	29	58	14	8	13	3.7
Wt	980								
Prog.BW	69								
WR	104								
YR	104								
Wean Pct.	60%								
Cow Eff.	126								
		Marb	+0.00		REA	+1.13		Bfat +0.00	
BWt	71	WWt	605	WR	104	ADG	3.60	YWt	1098
		YR		Scr.		Fr.			

★★★★★ for Low Maintenance, Rib-eye area, Superior Cow, High Cow Efficiency, Calving Ease, Stayability.

52 BECKTON EPIC W537 L5
1-A 100% # 1332197 Tattoo: BKT9 W537

Birth: 3-31-09
 Beckton Epic KJ J722
BECKTON EPIC K4 N795
 Ref. E-1
 Beckton Sierra J789 EP
 Beckton Epic K F075
 Beckton Lana F891 JL
 Beckton Epic D404
 Beckton Sierra C157 CL
 Beckton Lancer T A664
 Bkt Suffeina A828 DM
BECKTON KIT R517 LN
 Beckton Lancer F442 T
 Beckton Kit F468 JL
 Beckton Julian GG B571
 Beckton Kit A517 NP

DAM		Calv.Ease	BW	WW	YW	Milk	HPG	Stay	Maint.En.
Age	4	10	-1.3	31	67.5	9	5.5	13.5	-3.7
Wt	715								
Prog.BW	73								
WR	97								
YR	98								
Wean Pct.	89%								
Cow Eff.	187								
		Marb	+0.19		REA	+0.36		Bfat +0.00	
BWt	85	WWt	635	WR	100	ADG	3.47	YWt	1094
		YR		Scr.		Fr.			

★★★★★ for Low Maintenance, Marbling, Rib-eye area, High Cow Efficiency, Calving Ease, Stayability.



53 BECKTON NEBULA W185 L3
1-A 100% # 1332112 Tattoo: BKT9 W185

Birth: 3-12-09
 Beckton Nebula M045
BECKTON NEBULA J R475
 Ref. N-5
 Beckton Larkeisa M138 JC
 Beckton Neptune R2 K065
 Beckton Belga K285 JL
 Beckton Justice G302
 Bkt Larkeisa G448 CT
 Beckton Lancer F442 T
 Beckton Tamara G141 HE
BECKTON TAMARA P082 LN
 Beckton Lancer T7 M089
 Beckton Tamara M657 LN
 Beckton Lancer TS D390
 Beckton Tamara F182 CR

DAM		Calv.Ease	BW	WW	YW	Milk	HPG	Stay	Maint.En.
Age	5	12	-3.2	26	54	9	9	14	-6.6
Wt	1170								
Prog.BW	77								
WR	105								
YR	104								
Wean Pct.	47%								
Cow Eff.	100								
		Marb	-0.02		REA	+0.37		Bfat -0.01	
BWt	78	WWt	553	WR	95	ADG	4.05	YWt	1097
		YR		Scr.		Fr.			

★★★★★ for Low Maintenance, Gainability, Rib-eye area, Superior Cow, Calving Ease, Stayability.

51 BECKTON NEBULA W318 H3
1-A 100% # 1331626 Tattoo: BSF9 W318

Birth: 3-20-09
 Beckton Nebula M045
BECKTON NEBULA H R233
 Ref. N-4
 Beckton Coca H132 HD
 Beckton Neptune R2 K065
 Beckton Belga K285 JL
 Beckton Hadrian F C486
 Beckton Coca CB74 JV
 Beckton Hadrian A100
 Beckton Kuruba A444 FF
BECKTON BARMAID H504 HD
 Beckton Hadrian F C486
 Beckton Barmaid Z697 SU
 Beckton Sultan 8569V
 Bkt Barmaid 9190 RV

DAM		Calv.Ease	BW	WW	YW	Milk	HPG	Stay	Maint.En.
Age	11	17	-5.8	18	38	13	15	12	-7.8
Wt	1050								
Prog.BW	71								
WR	99								
YR	98								
Wean Pct.	54%								
Cow Eff.	113								
		Marb	-0.04		REA	+0.15		Bfat -0.01	
BWt	61	WWt	583	WR	98	ADG	3.56	YWt	1036
		YR		Scr.		Fr.			

★★★★★ for Low Maintenance, Rib-eye area, Calving Ease.

54 BECKTON EPIC W546 L4
1-A 100% # 1331622 Tattoo: BSF9 W546

Birth: 3-31-09
 Beckton Epic K F075
BECKTON EPIC R350 K
 Ref. E-2
 Beckton Larkaba E042 CD
 Beckton Epic D404
 Beckton Belga D483 KR
 Beckton Cody C401
 Beckton Larkaba C317 CL
 Beckton Lancer TZ D525
 Bkt Pine Marie D126 JL
BECKTON ANGEL H164 LO
 Beckton Loki F251
 Beckton Angel F571 LN
 Beckton Lancer T A664
 Beckton Angel B636 DM

DAM		Calv.Ease	BW	WW	YW	Milk	HPG	Stay	Maint.En.
Age	11	12	-3.5	29	62	20	7	15	0.5
Wt	1135								
Prog.BW	74								
WR	109								
YR	110								
Wean Pct.	56%								
Cow Eff.	117								
		Marb	+0.09		REA	+0.08		Bfat +0.01	
BWt	67	WWt	652	WR	109	ADG	4.05	YWt	1167
		YR		Scr.		Fr.			

★★★★★ for Low Maintenance, Growth, Gainability, Superior Cow, High Cow Efficiency, Calving Ease, Stayability.

• Bulls •



55 BECKTON JULIAN W354 E5
1-A 100% # 1331731 Tattoo: BSF9 W354

Birth: 3-21-09
 Beckton Julian GG B571
BECKTON JULIAN G3 P608
 Ref. J-3
 Beckton Julian 7526G
 Bkt Marta 9A13 JL
 Beckton Dominor 9455
 Bkt Suffeina 9493 TT
 Beckton Epic KJ J722
 Beckton Lana F268 CT
 Beckton Epic KJ J722
 Beckton Rose D731 CB

DAM		Calv.Ease	BW	WW	YW	Milk	HPG	Stay	Maint.En.
Age	5	14	-4.0	20	49	15	9	16	-1.0
Wt	1185	Marb +.09		REA +.07		Bfat +.01			
Prog.BW	71	BWt	WWt	WR	ADG	YWt	YR	Scr.	Fr.
WR	105	73	600	103	3.65	1108	103	36	5.0
YR	105								
Wean Pct.	51%								
Cow Eff.	107								

★★★★★ for Low Maintenance, Superior Cow, Calving Ease, Stayability.

56 BECKTON DOMINOR W599
1-A 100% # 1332050 Tattoo: BKT9 W599

Birth: 4-4-09
 Beckton Dominor ZC M919
BECKTON DOMINOR Z1 R610
 Ref. D-1
 Beckton Dominor Z E401
 Beckton Barmaid J012 CO
 Beckton Loki F251
 Beckton Sierra C157 CL
 Beckton Cody C401
 Beckton Birdie C353 VG
 Beckton Cody V E023
 Beckton Kuruba D537 CL
BECKTON KURUBA LC61 CD
 Beckton Clipper JM A124
 Bkt Kuruba 9120 JL

DAM		Calv.Ease	BW	WW	YW	Milk	HPG	Stay	Maint.En.
Age	8	11	-1.5	30	62	18	10	12	-2.8
Wt	1140	Marb +.10		REA +.05		Bfat +.01			
Prog.BW	76	BWt	WWt	WR	ADG	YWt	YR	Scr.	Fr.
WR	111	85	652	112	3.83	1154	108	34	5.5
YR	101								
Wean Pct.	57%								
Cow Eff.	120								

★★★★★ for Low Maintenance, Growth, High Cow Efficiency, Calving Ease.

58 BECKTON EPITOMY W148 C2
1-A 100% # 1331739 Tattoo: BSF9 W148

Birth: 3-9-09
 Beckton Epic K4 N795
BECKTON EPITOMY S250
 Ref. E-3
 Beckton Epic KJ J722
 Beckton Sierra J789 EP
 Beckton Julian GG B571
 Beckton Tara J266 HR
 Beckton Clipper K1 H772
 Beckton Lana H329 HD
 Beckton Cruiser K118
BECKTON ANGEL P156 CE
 Beckton Angel L717 LN
 Beckton Lancer TS D390
 Beckton Angel H227 EP

DAM		Calv.Ease	BW	WW	YW	Milk	HPG	Stay	Maint.En.
Age	5	12	-2.5	21	52	11	10	14	-0.9
Wt	1095	Marb +.11		REA -.10		Bfat +.02			
Prog.BW	66	BWt	WWt	WR	ADG	YWt	YR	Scr.	Fr.
WR	96	75	575	97	3.65	1063	100	34	5.0
YR	98								
Wean Pct.	53%								
Cow Eff.	111								

★★★★★ for Low Maintenance, Marbling, Calving Ease, Stayability.

57 BECKTON EPIC W602 H4
1-A 100% # 1332185 Tattoo: BKT9 W602

Birth: 4-4-09
 Beckton Epic K F075
BECKTON EPIC R350 K
 Ref. E-2
 Beckton Epic D404
 Beckton Belga D483 KR
 Beckton Cody C401
 Beckton Larkaba C317 CL
 Beckton Hustler C2 L079
 Beckton Lana L007 JL
 Beckton Heritage N013
BECKTON MONA R408 HT
 Beckton Hustler C2 L079
 Beckton Mona N444 HU
 Beckton Mona L136 JL

DAM		Calv.Ease	BW	WW	YW	Milk	HPG	Stay	Maint.En.
Age	4	10	-2.3	33	65	18	10	13	-3.3
Wt	845	Marb +.09		REA +.11		Bfat +.01			
Prog.BW	78	BWt	WWt	WR	ADG	YWt	YR	Scr.	Fr.
WR	109	78	629	106	4.23	1155	108	38	5.5
YR	109								
Wean Pct.	72%								
Cow Eff.	152								

★★★★★ for Low Maintenance, Growth, Gainability, Superior Cow, High Cow Efficiency, Calving Ease, Stayability.

59 BECKTON CLIFFTOP W276 N3
1-A 100% # 1332090 Tattoo: BKT9 W276

Birth: 3-18-09
 Beckton Clifftop T C075
BKT CLIFFTOP TP R288
 Ref. B-1
 Beckton Clifftop T C075
 Beckton Barmaid A761 TR
 Beckton Copper JT G095
 Beckton Christy A111 VQ
 Beckton Neptune R2 K065
BECKTON ANGEL N321 NP
 Beckton Angel F738 LN
 Beckton Neptune RR B284
 Beckton Lana C735 TP
 Beckton Lancer TZ D525
 Beckton Angel D302 RN

DAM		Calv.Ease	BW	WW	YW	Milk	HPG	Stay	Maint.En.
Age	6	13	-4.9	22	47	15	7	13	-5.0
Wt	1160	Marb +.08		REA +.12		Bfat -.01			
Prog.BW	69	BWt	WWt	WR	ADG	YWt	YR	Scr.	Fr.
WR	101	67	582	100	4.01	1128	105	35	5.0
YR	100								
Wean Pct.	50%								
Cow Eff.	106								

★★★★★ for Low Maintenance, Gainability, Calving Ease, Stayability.

• Bulls •

60 BECKTON WARRIOR W091 N4
1-A 100% # 1331708 Tattoo: BSF9 W091

Birth: 3-4-09
 Beckton Warrior CL M686
BECKTON WARRIOR C1 S337
 Ref. W-2 Beckton Christy K101 CD
 Beckton Warrior C C355
 Beckton Christy J223 LN
 Beckton Cody V E023
 Beckton Christy C306 JL
 Beckton Neptune RR B284
 Beckton Lana C735 TP
 Beckton Cobalt V AC03
 Beckton Belga 9582VC
BECKTON BELGA N308 NP
 Beckton Neptune R2 K065
 Beckton Belga HC71 CB

DAM		Calv.Ease	BW	WW	YW	Milk	HPG	Stay	Maint.En.
Age	6	12	-3.4	26	53	18	12	12	1.6
Wt	1170								
Prog.BW	71								
WR	110			Marb +.11	REA +.08		Bfat -.01		
YR	108								
Wean Pct.	52%	BWt	WWt	WR	ADG	YWt	YR	Scr.	Fr.
Cow Eff.	109	76	606	104	3.51	1069	100	34	5.0

★★★★★ for Low Maintenance, Marbling, Superior Cow, Calving Ease.

63 BECKTON WARRIOR W420 C4
1-A 100% # 1332031 Tattoo: BKT9 W420

Birth: 3-25-09
 Beckton Warrior CL M686
BECKTON WARRIOR C1 S337
 Ref. W-2 Beckton Christy K101 CD
 Beckton Warrior C C355
 Beckton Christy J223 LN
 Beckton Cody V E023
 Beckton Christy C306 JL
 Beckton Colter HW J766
 Beckton Minerva E200 WR
 Beckton Vegas PK F485
 Beckton Serena F381 EM
BECKTON SERENA L042 CR
 Beckton Colter HW J766
 Beckton Serena J629 VG

DAM		Calv.Ease	BW	WW	YW	Milk	HPG	Stay	Maint.En.
Age	8	16	-5.2	24	46	16	11	11	0.6
Wt	1135								
Prog.BW	71								
WR	105			Marb +.05	REA -.03		Bfat -.01		
YR	101								
Wean Pct.	55%	BWt	WWt	WR	ADG	YWt	YR	Scr.	Fr.
Cow Eff.	116	65	625	105	3.06	1070	100	36	5.5

★★★★★ for Low Maintenance, High Cow Efficiency, Calving Ease.

61 BECKTON LANCER W006 E5
1-A 100% # 1332387 Tattoo: BKT9 W006

Birth: 2-16-09
 Beckton Lancer F442 T
BECKTON LANCER T371 H4
 Ref. L-3 Beckton Coca F276 HV
 Beckton Lancer T A664
 Bkt Suffeina A828 DM
 Leachman Heavenly 8141
 Beckton Coca B112 CB
 Beckton Epic K F075
 Beckton Minerva F495 CH
 Beckton Copper JT G095
 Beckton Firefly K180 CH
BECKTON FIREFLY T331 EP
 Beckton Epic KM M115
 Beckton Firefly N457 CO

DAM		Calv.Ease	BW	WW	YW	Milk	HPG	Stay	Maint.En.
Age	2	10	-2.7	32	71	19	8	15	4.3
Wt	1050								
Prog.BW	56								
WR	105			Marb +.10	REA +.07		Bfat -.01		
YR	109								
Wean Pct.	47%	BWt	WWt	WR	ADG	YWt	YR	Scr.	Fr.
Cow Eff.	98	56	549	105	3.92	1091	109	32	5.0

★★★★★ for Growth, Superior Cow, Calving Ease, Stayability.

64 BECKTON NEBULA W605 E3
1-A 100% # 1332030 Tattoo: BKT9 W605

Birth: 4-4-09
 Beckton Nebula M045
BECKTON NEBULA L P093
 Ref. N-2 Beckton Marta M021 LN
 Beckton Neptune R2 K065
 Beckton Belga K285 JL
 Beckton Lancer TA K644
 Beckton Marta K254 LN
 Beckton Saga KJ B702
 Beckton Kuruba B508 PC
 Beckton Julian GN 9A45
 Bkt Minerva 7016 TJ
BECKTON MINERVA K929 EP
 Beckton Epic D404
 Beckton Minerva CB69 JL

DAM		Calv.Ease	BW	WW	YW	Milk	HPG	Stay	Maint.En.
Age	NA	11	-2.4	27	55	8	12	14	-5.3
Wt	1110								
Prog.BW	80								
WR	105			Marb +.08	REA +.20		Bfat +.01		
YR	104								
Wean Pct.	57%	BWt	WWt	WR	ADG	YWt	YR	Scr.	Fr.
Cow Eff.	119	75	629	118	3.56	1090	106	34	5.5

★★★★★ for Low Maintenance, Rib-eye area, Superior Cow, High Cow Efficiency, Calving Ease, Stayability.

62 BECKTON JET W452 E2
1-A 100% # 1332103 Tattoo: BKT9 W452

Birth: 3-26-09
 TR Julian LT151
BECKTON JET L P491
 Ref. J-2 Beckton Minerva L278 LN
 Beckton Julian GG B571
 MS Geometric 917
 Beckton Lancer TS D390
 Beckton Minerva F495 CH
 Beckton Epic K F075
 Beckton Lana F891 JL
 Beckton Lancelot F045
 Bkt Pine Marie F599 CD
BKT PINE MARIE N719 EP
 Beckton Epic KJ J722
 BKT Pine Marie H379 LA

DAM		Calv.Ease	BW	WW	YW	Milk	HPG	Stay	Maint.En.
Age	6	14	-4.2	21	44	14	8	13	-4.1
Wt	1040								
Prog.BW	63								
WR	97			Marb +.08	REA +.11		Bfat +.01		
YR	95								
Wean Pct.	57%	BWt	WWt	WR	ADG	YWt	YR	Scr.	Fr.
Cow Eff.	120	73	593	100	3.65	1094	102	35	5.0

★★★★★ for Low Maintenance, High Cow Efficiency, Calving Ease, Stayability.



• Bulls •



65 **BSF CLIFFTOP W221 H3**
1-B 99% # 1331814 Tattoo: BSF9 W221

Birth: 3-15-09
 ↗ Beckton Clifftop T C075 ↘ BJR Topper 5241
 ↗ Beckton Barmaid A761 TR ↘
BKT CLIFFTOP TP R288
 Ref. B-1 ↗ Beckton Christy K209 CO ↘ Beckton Copper JT G095
 ↗ Beckton Christy A111 VQ ↘
 ↗ Beckton Hustler CN J102 ↘ Beckton Hustler C G407
BSF HUSTELLE R608 HU ↗ Beckton Belga G355 NP ↘
 ↗ BSF Regus L862 CL ↘ Beckton Clipper KH F416
 ↗ BSF Regus Z776 ↘

DAM		Calv.Ease	BW	WW	YW	Milk	HPG	Stay	Maint.En.
Age	4	11	-3.6	25	58	16	8	10	-0.6
Wt	1045								
Prog.BW	69								
WR	100		Marb	-0.02	REA	+0.21	Bfat	-0.01	
YR	104								
Wean Pct.	53%	BWt	WWt	WR	ADG	YWt	YR	Scr.	Fr.
Cow Eff.	112	72	578	100	4.05	1121	105	40	5.0

★★★★★ for Low Maintenance, Gainability, Rib-eye area, Calving Ease.

66 **BSF NEBULANN W109 N**
1-2 99% # 1331684 Tattoo: BSF9 W109

Birth: 3-6-09
 ↗ Beckton Nebula M045 ↘ Beckton Neptune R2 K065
 ↗ Beckton Belga K285 JL ↘
BECKTON NEBULA G S237
 Ref. N-6 ↗ Beckton Lakme LA06 JL ↘ Beckton Julian GG B571
 ↗ Beckton Lakme B370 HV ↘
 ↗ Beckton Lancer T4 J536 ↘ Beckton Lancer TZ D525
BSF REGUS M595 LN ↗ Beckton Vernice D121 VG ↘
 ↗ BSF Red H200 ↘ Beckton Champ RH F275
 ↗ BSF Regus F502 ↘

DAM		Calv.Ease	BW	WW	YW	Milk	HPG	Stay	Maint.En.
Age	7	17	-5.2	22	47	12	9	14	-5.6
Wt	1130								
Prog.BW	66								
WR	103		Marb	+0.07	REA	-0.05	Bfat	+0.00	
YR	101								
Wean Pct.	53%	BWt	WWt	WR	ADG	YWt	YR	Scr.	Fr.
Cow Eff.	112	64	603	101	4.60	1065	100	39	5.0

★★★★★ for Low Maintenance, Gainability, Calving Ease, Stayability.

68 **BSF NEBULA W140 L3**
1-B 99% # 1331717 Tattoo: BSF9 W140

Birth: 3-9-09
 ↗ Beckton Nebula M045 ↘ Beckton Neptune R2 K065
 ↗ Beckton Belga K285 JL ↘
BECKTON NEBULA H R233
 Ref. N-4 ↗ Beckton Coca H132 HD ↘ Beckton Hadrian F C486
 ↗ Beckton Coca CB74 JV ↘
 ↗ Beckton Lancer TZ D525 ↘ Beckton Lancer TZ D525
BSF LAUREL N411 LO ↗ Bkt Pine Marie D126 JL ↘
 ↗ BSF Regus G195 ↘ Beckton Emperor C369
 ↗ BSF Regus 8099 ↘

DAM		Calv.Ease	BW	WW	YW	Milk	HPG	Stay	Maint.En.
Age	6	11	-2.3	27	53	14	10	13	-6.5
Wt	1135								
Prog.BW	72								
WR	99		Marb	+0.17	REA	+0.16	Bfat	+0.00	
YR	99								
Wean Pct.	54%	BWt	WWt	WR	ADG	YWt	YR	Scr.	Fr.
Cow Eff.	113	83	607	102	3.69	1056	99	36	5.0

★★★★★ for Low Maintenance, Marbling, Rib-eye area, Calving Ease, Stayability.

67 **BSF JULIO W074 J3**
1-B 99% # 1331967 Tattoo: BSF9 W074

Birth: 3-2-09
 ↗ Beckton Julio L233 ↘ Beckton Julian G1 J526
 ↗ Beckton Rose J725 EP ↘
BECKTON JULIO T863 H2
 Ref. J-8 ↗ Beckton Vernice N598 HU ↘ Beckton Hustler CN J102
 ↗ Beckton Vernice C047 JL ↘
 ↗ Beckton Julio L233 ↘ Beckton Julian G1 J526
BSF JULIA T623 JO ↗ Beckton Rose J725 EP ↘
 ↗ BSF Regus M006 NP ↘ Beckton Neptune R2 K065
 ↗ BSF Regus K326 WH ↘

DAM		Calv.Ease	BW	WW	YW	Milk	HPG	Stay	Maint.En.
Age	2	9	-1.3	32	74	14	7	14	-2.8
Wt	810								
Prog.BW	73								
WR	108		Marb	+0.04	REA	+0.03	Bfat	+0.00	
YR	110								
Wean Pct.	64%	BWt	WWt	WR	ADG	YWt	YR	Scr.	Fr.
Cow Eff.	135	73	577	108	4.01	1085	110	36	5.5

★★★★★ for Low Maintenance, Growth, Gainability, Superior Cow, High Cow Efficiency, Calving Ease, Stayability.

69 **BSF JUSTICE W595 E5**
1-B 99% # 1331850 Tattoo: BSF9 W595

Birth: 4-3-09
 ↗ Beckton Justice CH M056 ↘ Beckton Justice C K449
 ↗ Beckton Ruth K802 HD ↘
BECKTON JUSTICE C1 R483
 Ref. J-4 ↗ Beckton Tamara J124 HR ↘ Beckton Herald F FA20
 ↗ Beckton Tamara F183 CT ↘
 ↗ Beckton Epic K5 P071 ↘ Beckton Epic KM M115
BSF CRUSITA S100 EP ↗ Beckton Minerva M179 LN ↘
 ↗ BSF Crusita P634 ↘ Beckton Cruiser K118
 ↗ BSF Regus L314 WR ↘

DAM		Calv.Ease	BW	WW	YW	Milk	HPG	Stay	Maint.En.
Age	3	13	-2.3	33	68	18	12	12	-3.8
Wt	860								
Prog.BW	70								
WR	108		Marb	+0.14	REA	-0.02	Bfat	+0.00	
YR	101								
Wean Pct.	73%	BWt	WWt	WR	ADG	YWt	YR	Scr.	Fr.
Cow Eff.	153	72	663	116	3.20	1127	108	33	5.5

★★★★★ for Low Maintenance, Growth, Marbling, High Cow Efficiency, Calving Ease.

• Bulls •

70 **BSF NEBULA W249 V3**
1-B 99% # 1331619 Tattoo: BSF9 W249

Birth: 3-16-09
 Beckton Nebula M045
BECKTON NEBULA J R475
 Ref. N-5
 Beckton Larkeisa M138 JC
 Beckton Neptune R2 K065
 Beckton Belga K285 JL
 Beckton Justice G302
 Bkt Larkeisa G448 CT
 Beckton Vegas 9433
 Beckton Angel Z637 SU
 Beckton Vegas P D462
 WF Regus D695
 Beckton Vegas S F382
BSF REGUS H098
 BSF Regus F215

DAM		Calv.Ease	BW	WW	YW	Milk	HPG	Stay	Maint.En.
Age	11	10	-1.0	34	64	11	12	13	-7.3
Wt	1025								
Prog.BW	75								
WR	108		Marb +.00		REA +.16		Bfat -.01		
YR	106								
Wean Pct.	61%	BWt	WWt	WR	ADG	YWt	YR	Scr.	Fr.
Cow Eff.	129	85	650	112	3.87	1173	109	32	5.0

★★★★★ for Low Maintenance, Growth, Rib-eye area, Superior Cow, High Cow Efficiency, Calving Ease, Stayability.

72 **TR JULIAN WT951**
1-A 100% # 1324422 Tattoo: TR2A9 WT95

Birth: 2-20-09
 Beckton Julian GG B571
TR JULIAN LT151
 Ref.
 Ms Geometric 917
 Beckton Cody V E023
TR LANA G760
 Beckton Lana E828 SC
 BKT Julian 7526 G
 BKT Marta 9A13 JL
 BJR Yo 121
 Ms Geometric
 Beckton Cody C401
 Beckton Birdie C353 VG
 Beckton Scamp 8954
 Beckton Lana B695 SG

DAM		Calv.Ease	BW	WW	YW	Milk	HPG	Stay	Maint.En.
Age	12	15	-2.7	36	67	16	15	13	4.8
Wt	NA								
Prog.BW	NA								
WR	NA		Marb +.16		REA +.08		Bfat +.01		
YR	NA								
Wean Pct.	NA%	BWt	WWt	WR	ADG	YWt	YR	Scr.	Fr.
Cow Eff.	NA	80	715	121	3.26	1236	110	NA	5.5

★★★★★ for Growth, Marbling, Calving Ease, Stayability.



73 **TR RICARDO WT963**
1-A 100% # 1324437 Tattoo: TR2A9 WT96

Birth: 3-13-09
 Bfck Cherokee Cnyn 4912
TR RICARDO RT574
 Ref.
 TR Dyna LT111
 Buf Crk Romeo L081
TR MINOLA NT309
 Buf Crk Minola L387
 Buf Crk Chf 824-1658
 MRM 1431 8611 9109
 Beckton Julian GG B571
 BSF Dyna JT976
 Beckton Julian GG B571
 Buf Crk Primrose 5679
 Buf Crk Counterchf 5107
 Buf Crk Minola 5001

DAM		Calv.Ease	BW	WW	YW	Milk	HPG	Stay	Maint.En.
Age	6	10	-1.1	39	78	20	12	15	-0.4
Wt	NA								
Prog.BW	NA								
WR	NA		Marb +.16		REA +.17		Bfat +.01		
YR	NA								
Wean Pct.	NA%	BWt	WWt	WR	ADG	YWt	YR	Scr.	Fr.
Cow Eff.	NA	89	700	118	3.66	1285	114	NA	6.0

★★★★★ for Low Maintenance, Growth, Marbling, Rib-eye area, Calving Ease, Stayability. **Selling 1/2 Interest & Full Possession.**

71 **TR JAX WT974**
1-A 100% # 1324457 Tattoo: TR2A9 WT97

Birth: 3-19-09
 Beckton Julian GG B571
TR JULIAN ST630
 Ref.
 Ms Geometric 003
 Beckton Epic KJ J722
TR CHRISTY RT528
 Beckton Christy L543 JL
 BKT Julian 7526 G
 BKT Marta 9A13 JL
 BJR Make My Day 981
 Ms Geometric 277
 Beckton Epic K F075
 Beckton Lana F891 JL
 Beckton Julian J153 G
 Beckton Christy D409 NM

DAM		Calv.Ease	BW	WW	YW	Milk	HPG	Stay	Maint.En.
Age	4	10	-0.2	38	75	11	10	15	2.7
Wt	NA								
Prog.BW	NA								
WR	NA		Marb +.07		REA +.24		Bfat +.01		
YR	NA								
Wean Pct.	NA%	BWt	WWt	WR	ADG	YWt	YR	Scr.	Fr.
Cow Eff.	NA	88	690	117	3.79	1296	115	NA	6.5

★★★★★ for Low Maintenance, Growth, Rib-eye area, Calving Ease, Stayability. **Selling 1/2 Interest & Full Possession.**

74 **TR JULIAN WT977**
1-A 100% # 1324463 Tattoo: TR2A9 WT97

Birth: 2-19-09
 Beckton Julian GG B571
TR JULIAN LT151
 Ref.
 Ms Geometric 917
 TR Julian LT142
TR DYNA ST605
 TR Dyna HT824
 BKT Julian 7526 G
 BKT Marta 9A13 JL
 BJR Yo 121
 Ms Geometric
 Beckton Julian GG B571
 TR Lana G760
 Buf Crk Dynamics 3820
 Buf Crk Dyna 3082

DAM		Calv.Ease	BW	WW	YW	Milk	HPG	Stay	Maint.En.
Age	3	12	-0.3	34	70	11	13	16	7.1
Wt	NA								
Prog.BW	NA								
WR	NA		Marb +.18		REA -.06		Bfat +.00		
YR	NA								
Wean Pct.	NA%	BWt	WWt	WR	ADG	YWt	YR	Scr.	Fr.
Cow Eff.	NA	91	570	96	3.87	1189	106	NA	5.5

★★★★★ for Growth, Marbling, Calving Ease, Stayability.

• Bulls •

75 TR RICARDO WT964
1-A 100% # 1324438 Tattoo: TR2A9 WT96

Birth: 2-13-09
 Bfck Cherokee Cnyn 4912 < Buf Crk Chf 824-1658
 MRM 1431 8611 9109
TR RICARDO RT574
 Ref. TR Dyna LT111 < Beckton Julian GG B571
 BSF Dyna JT976
 < Beckton Julian GG B571
TR PINEMARIE NT311
 Buf Crk Romeo L081 < Buf Crk Primrose 5679
 Buf Crk PineMarie L279 < Buf Crk Iowa 2886
 Buf Crk PineMarie 4987

DAM		Calv.Ease	BW	WW	YW	Milk	HPG	Stay	Maint.En.
Age	6	13	-4.2	29	49	19	10	14	-1.9
Wt	NA	Marb +.13		REA +.21		Bfat +.01			
Prog.BW	NA	BWt	WWt	WR	ADG	YWt	YR	Scr.	Fr.
WR	NA	72	618	104	2.90	1082	96	NA	5.5
YR	NA								
Wean Pct.	NA%								
Cow Eff.	NA								

★★★★★ for Low Maintenance, Marbling, Rib-eye area, Calving Ease, Stayability.

78 BECKTON LANCER W119 E5
1-A 100% # 1332468 Tattoo: BKT9 W119

Birth: 3-7-09
 Beckton Lancer F442 T < Beckton Lancer T A664
 Bkt Suffeina A828 DM
BECKTON LANCER T371 H4
 Ref. L-3 < Beckton Coca F276 HV
 < Leachman Heavenly 8141
 Beckton Coca B112 CB
 < Beckton Epic K F075
BECKTON LAKME T692 EP
 Beckton Epic KM M115 < Beckton Minerva F495 CH
 Beckton Lakme P513 EP < Beckton Epic K F075
 Beckton Lakme K697 CT

DAM		Calv.Ease	BW	WW	YW	Milk	HPG	Stay	Maint.En.
Age	2	8	-1.3	34	79	18	9	15	-0.5
Wt	865	Marb +.05		REA +.12		Bfat -.01			
Prog.BW	70	BWt	WWt	WR	ADG	YWt	YR	Scr.	Fr.
WR	107	70	570	107	4.51	1160	117	38	5.5
YR	117								
Wean Pct.	59%								
Cow Eff.	124								

★★★★★ for Low Maintenance, Growth, Gainability, Superior Cow, High Cow Efficiency, Calving Ease, Stayability.

76 BECKTON JULES W421 A2
1-A 100% # 1331845 Tattoo: BSF9 W421

Birth: 3-25-09
 Beckton Julian G1 J526 < Beckton Julian GG B571
 Beckton Annie F743 LN
BECKTON JULES L429
 Ref. J < Beckton Epic K F075
 Beckton Barona E134 RN
 < Beckton Cody KH M390
BECKTON ANGEL S037 CD
 Beckton Cody K1 P014 < Beckton Rose M126 WR
 Beckton Angel P156 CE < Beckton Cruiser K118
 Beckton Angel L717 LN

DAM		Calv.Ease	BW	WW	YW	Milk	HPG	Stay	Maint.En.
Age	3	12	-2.2	28	69	15	9	15	2.9
Wt	1105	Marb +.00		REA +.13		Bfat +.01			
Prog.BW	69	BWt	WWt	WR	ADG	YWt	YR	Scr.	Fr.
WR	100	80	591	105	4.78	1185	115	36	5.5
YR	107								
Wean Pct.	50%								
Cow Eff.	105								

★★★★★ for Low Maintenance, Growth, Gainability, Rib-eye area, Calving Ease, Stayability.



77 BECKTON RANGER W179 E4
1-A 100% # 1332405 Tattoo: BKT9 W179

Birth: 3-12-09
 Beckton Ranger 9479R < Beckton Ranger 7003
 Beckton Eola 7470 RZ
BECKTON RANGER T603 H3
 Ref. R-1 < Beckton Hustler C2 L079
 Beckton Rose L669 JL
 < Beckton Epic K F075
BECKTON ROSE T406 EP
 Beckton Epic KM M115 < Beckton Minerva F495 CH
 Beckton Lancer TH K417
 Beckton Rose N375 LN < Beckton Rose D731 CB

DAM		Calv.Ease	BW	WW	YW	Milk	HPG	Stay	Maint.En.
Age	2	12	-4.1	28	67	18	10	12	-4.3
Wt	860	Marb +.12		REA -.13		Bfat +.01			
Prog.BW	55	BWt	WWt	WR	ADG	YWt	YR	Scr.	Fr.
WR	112	55	582	112	4.05	1131	113	35	5.5
YR	113								
Wean Pct.	61%								
Cow Eff.	128								

★★★★★ for Low Maintenance, Growth, Gainability, Marbling, Superior Cow, High Cow Efficiency, Calving Ease.

79 BECKTON EPIC W719 J5
1-A 100% # 1332136 Tattoo: BKT9 W719

Birth: 4-14-09
 Beckton Epic KJ J722 < Beckton Epic K F075
 Beckton Lana F891 JL
BECKTON EPIC K4 N795
 Ref. E-1 < Beckton Epic D404
 Beckton Sierra C157 CL
 < Beckton Julian 7526G
BECKTON SUFFEINA P643 JL
 Beckton Julian GG B571 < Bkt Marta 9A13 JL
 Bkt Suffeina A828 DM < Beckton Dominor 9455
 Bkt Suffeina 9493 TT

DAM		Calv.Ease	BW	WW	YW	Milk	HPG	Stay	Maint.En.
Age	5	11	-1.4	32	73	13	7	15	-1.1
Wt	1025	Marb +.21		REA +.22		Bfat +.01			
Prog.BW	75	BWt	WWt	WR	ADG	YWt	YR	Scr.	Fr.
WR	107	77	620	107	3.83	1134	106	37	5.0
YR	107								
Wean Pct.	61%								
Cow Eff.	127								

★★★★★ for Low Maintenance, Growth, Marbling, Rib-eye area, Superior Cow, High Cow Efficiency, Calving Ease, Stayability. **Selling 1/2 Interest & Full Possession.**

• Bulls •

80 BECKTON NEBULA W030 J4
1-A 100% # 1332415 Tattoo: BKT9 W030

Birth: 2-23-09
 Beckton Nebula L P093
BECKTON NEBULA T252 L3
 Ref. N-10 Beckton Vernice L382 LN
 Beckton Nebula M045
 Beckton Marta M021 LN
 Beckton Lancer TZ D525
 Beckton Vernice G373 WR
 Beckton Julian G1 J526
 Beckton Serena D760 KR
BECKTON LANA T442 JJ
 Beckton Juno N493
 Beckton Lana L538 LN
 Beckton Lancer TL G626
 Beckton Lana G514 CD

DAM		Calv.Ease	BW	WW	YW	Milk	HPG	Stay	Maint.En.
Age	2	14	-4.0	29	60	13	5	14	-4.1
Wt	825								
Prog.BW	59								
WR	99								
YR	106								
Wean Pct.	57%								
Cow Eff.	120								
		Marb			REA			Bfat	
		BWt	WWt	WR	ADG	YWt	YR	Scr.	Fr.
		59	530	99	4.01	1048	106	35	5.5

★★★★★ for Low Maintenance, Gainability, Marbling, High Cow Efficiency, Calving Ease, Stayability.

83 BECKTON NEBULA W072 E4
1-A 100% # 1332473 Tattoo: BKT9 W072

Birth: 3-2-09
 Beckton Nebula L P093
BECKTON NEBULA T398 V3
 Ref. N-11 Beckton Minerva J615 VG
 Beckton Nebula M045
 Beckton Marta M021 LN
 Beckton Vegas PK F485
 Beckton Minerva F433 VG
 Beckton Epic KJ J722
 Beckton Lana F268 CT
BECKTON LANA T723 EP
 Beckton Epic K3 M606
 Beckton Lana N378 LN
 Beckton Lancer T5 L095
 Beckton Lana L367 LN

DAM		Calv.Ease	BW	WW	YW	Milk	HPG	Stay	Maint.En.
Age	2	9	-0.8	34	66	11	7	14	-3.4
Wt	NA								
Prog.BW	68								
WR	107								
YR	104								
Wean Pct.	61%								
Cow Eff.	129								
		Marb			REA			Bfat	
		BWt	WWt	WR	ADG	YWt	YR	Scr.	Fr.
		68	560	107	3.78	1045	104	35	5.5

★★★★★ for Low Maintenance, Rib-eye area, Superior Cow, High Cow Efficiency, Calving Ease, Stayability.

81 BECKTON JULIAN W292 J5
1-A 100% # 1332166 Tattoo: BKT9 W292

Birth: 3-19-09
 Beckton Julian GG B571
BECKTON JULIAN G3 P608
 Ref. J-3 Bkt Suffeina A828 DM
 Beckton Julian 7526G
 Bkt Marta 9A13 JL
 Beckton Dominor 9455
 Bkt Suffeina 9493 TT
 Beckton Justice G302
 Beckton Julian GG B571
BECKTON MINERVA R183 JC
 Beckton Minerva F495 CH
 Bkt Vernice 9733 PC
 Beckton Champ R A583
 Beckton Minerva CB69 JL

DAM		Calv.Ease	BW	WW	YW	Milk	HPG	Stay	Maint.En.
Age	4	14	-2.5	23	50	10	12	15	-5.9
Wt	1060								
Prog.BW	71								
WR	96								
YR	100								
Wean Pct.	49%								
Cow Eff.	104								
		Marb			REA			Bfat	
		BWt	WWt	WR	ADG	YWt	YR	Scr.	Fr.
		82	541	93	3.69	1052	98	34	5.5

★★★★★ for Low Maintenance, Calving Ease, Stayability.

84 BECKTON EPIC W718 L5
1-A 100% # 1332006 Tattoo: BKT9 W718

Birth: 4-14-09
 Beckton Epic KJ J722
BECKTON EPIC K4 N795
 Ref. E-1 Beckton Sierra J789 EP
 Beckton Epic K F075
 Beckton Lana F891 JL
 Beckton Epic D404
 Beckton Sierra C157 CL
 Beckton Lancer TS D390
 Beckton Lancer T A664
BKT LARKEISA H478 LN
 Beckton Larkeisa C159 CL
 Beckton Coca 7536 SB
 Beckton Clipper K Z420
 Bkt Larkeisa 7032 TJ

DAM		Calv.Ease	BW	WW	YW	Milk	HPG	Stay	Maint.En.
Age	11	10	-2.9	26	68	12	4	13	2.1
Wt	1075								
Prog.BW	74								
WR	100								
YR	100								
Wean Pct.	54%								
Cow Eff.	114								
		Marb			REA			Bfat	
		BWt	WWt	WR	ADG	YWt	YR	Scr.	Fr.
		72	600	101	3.78	1113	105	38	5.5

★★★★★ for Low Maintenance, Marbling, Calving Ease, Stayability.

82 BECKTON WARRIOR W444 R5
1-A 100% # 1331889 Tattoo: BSF9 W444

Birth: 3-26-09
 Beckton Warrior T1 H281
BECKTON WARRIOR N645 T1
 Ref. W-1 Beckton Rose H074 EP
 Beckton Warrior TC E801
 Beckton Minerva B609 RN
 Beckton Epic K F075
 Beckton Rose F791 EM
 Beckton Ranger 9479R
 Beckton Ranger 7003
BECKTON MARTA S441 RN
 Beckton Eola 7470 RZ
 Beckton Epic K F075
 Beckton Marta K386 EP
 Beckton Marta G675 LN

DAM		Calv.Ease	BW	WW	YW	Milk	HPG	Stay	Maint.En.
Age	3	12	-4.2	28	63	8	9	11	-3.0
Wt	975								
Prog.BW	58								
WR	101								
YR	104								
Wean Pct.	53%								
Cow Eff.	111								
		Marb			REA			Bfat	
		BWt	WWt	WR	ADG	YWt	YR	Scr.	Fr.
		64	554	101	4.01	1079	104	34	5.5

★★★★★ for Low Maintenance, Gainability, Marbling, Calving Ease.

85 BECKTON NEBULA W181 N4
1-A 100% # 1332463 Tattoo: BKT9 W181

Birth: 3-12-09
 Beckton Nebula L P093
BECKTON NEBULA T252 L3
 Ref. N-10 Beckton Vernice L382 LN
 Beckton Nebula M045
 Beckton Marta M021 LN
 Beckton Lancer TZ D525
 Beckton Vernice G373 WR
 Beckton Nebula L P093
 Beckton Nebula M045
BECKTON ANGEL T652 NB
 Beckton Angel H164 LO
 Beckton Marta M021 LN
 Beckton Loki F251
 Beckton Angel F571 LN

DAM		Calv.Ease	BW	WW	YW	Milk	HPG	Stay	Maint.En.
Age	2	13	-3.7	32	70	12	8	15	-2.4
Wt	880								
Prog.BW	58								
WR	107								
YR	108								
Wean Pct.	58%								
Cow Eff.	123								
		Marb			REA			Bfat	
		BWt	WWt	WR	ADG	YWt	YR	Scr.	Fr.
		58	572	107	3.96	1069	108	33	5.5

★★★★★ for Low Maintenance, Growth, Rib-eye area, Superior Cow, High Cow Efficiency, Calving Ease, Stayability.

• Bulls •



88

BECKTON EPIC W657 L5

1-A 100% # 1332296 Tattoo: BKT9 W657

Birth: 4-9-09

Beckton Epic KJ J722
 Beckton Epic K F075
 Beckton Lana F891 JL
BECKTON EPIC K4 N795
 Ref. E-1
 Beckton Sierra J789 EP
 Beckton Epic D404
 Beckton Sierra C157 CL
 Beckton Lancer T A664
 Bkt Suffeina A828 DM
BECKTON LANA S718 LN
 Beckton Lancer F442 T
 Beckton Lana F891 JL
 Beckton Clifftop T C075
 Beckton Lana 9610 TP

DAM		Calv.Ease	BW	WW	YW	Milk	HPG	Stay	Maint.En.
Age	3	6	1.1	35	81	10	3	14	6.5
Wt	1170								
Prog.BW	74								
WR	104			Marb +0.22	REA +0.28			Bfat -0.01	
YR	107								
Wean Pct.	47%								
Cow Eff.	98								
BWt	WWt	WR	ADG	YWt	YR	Scr.	Fr.		
81	585	104	4.23	1133	110	31	5.5		

★★★★★ for Growth, Gainability, Marbling, Rib-eye area, Superior Cow, Stayability.

86

BECKTON HASTEN W670 L3

1-A 100% # 1331616 Tattoo: BSF9 W670

Birth: 4-9-09

Beckton Hasten P292
 Beckton Sheba L644 CH
BECKTON HASTEN H S462
 Ref. H-2
 Beckton Lakme G128 HD
 Beckton Hadrian FC E166
 Beckton Lakme E373 CL
 Beckton Lancer T A664
 Beckton Lancer 9380
 Beckton Coca 9119 TJ
BECKTON MARTA G675 LN
 Bkt Marta 9A13 JL
 Beckton Julian 7526G
 Bkt Marta 6498 XM

DAM		Calv.Ease	BW	WW	YW	Milk	HPG	Stay	Maint.En.
Age	12	16	-5.4	26	58	17	9	15	1.7
Wt	1140								
Prog.BW	69								
WR	102			Marb +0.09	REA +0.14			Bfat -0.01	
YR	101								
Wean Pct.	49%								
Cow Eff.	103								
BWt	WWt	WR	ADG	YWt	YR	Scr.	Fr.		
64	575	97	3.87	1086	102	38	5.0		

★★★★★ for Low Maintenance, Rib-eye area, Calving Ease, Stayability.

89

BECKTON NEBULA W014 N4

1-A 100% # 1332467 Tattoo: BKT9 W014

Birth: 2-19-09

Beckton Nebula J R475
 Beckton Nebula M045
 Beckton Larkeisa M138 JC
BECKTON NEBULA T054 H3
 Ref. N-9
 BKT Pine Marie R401 HU
 Beckton Hustler C2 L079
 Bkt Pine Marie LC30 CD
 Beckton Nexus L016
 Beckton Neptune R1 J245
 Beckton Coca J276 CL
BECKTON LAKME T689 NX
 Beckton Lakme M669 EP
 Beckton Epic K F075
 Beckton Lakme F560 TP

DAM		Calv.Ease	BW	WW	YW	Milk	HPG	Stay	Maint.En.
Age	2	11	-3.0	33	76	12	12	12	-0.8
Wt	900								
Prog.BW	70								
WR	109			Marb +0.11	REA +0.15			Bfat +0.00	
YR	110								
Wean Pct.	56%								
Cow Eff.	119								
BWt	WWt	WR	ADG	YWt	YR	Scr.	Fr.		
70	567	109	4.14	1107	110	37	5.0		

★★★★★ for Low Maintenance, Growth, Gainability, Marbling, Rib-eye area, Superior Cow, High Cow Efficiency, Calving Ease.

87

BECKTON LOKI W509 C4

1-A 100% # 1332181 Tattoo: BKT9 W509

Birth: 3-29-09

Beckton Loki C M740
 Beckton Loki F251
 BKT Larkeisa J051 CK
BECKTON LOKI CL S284
 Ref. L-2
 Beckton Lakme J460 LT
 Beckton Latigo G714
 Beckton Lakme G128 HD
 Beckton Champ R1 H024
 Beckton Champ RH F275
 Beckton Lana F138 LN
BECKTON ROSE R340 CH
 Beckton Rose H292 HD
 Beckton Hadrian F C486
 Beckton Rose A528 PC

DAM		Calv.Ease	BW	WW	YW	Milk	HPG	Stay	Maint.En.
Age	4	15	-5.8	23	48	16	10	12	-2.6
Wt	950								
Prog.BW	66								
WR	96			Marb +0.04	REA -0.07			Bfat -0.02	
YR	98								
Wean Pct.	61%								
Cow Eff.	127								
BWt	WWt	WR	ADG	YWt	YR	Scr.	Fr.		
65	595	100	3.24	1019	96	39	5.5		

★★★★★ for Low Maintenance, High Cow Efficiency, Calving Ease.

90

BECKTON SUFFEINA W228 C

1-A 100% # 1331639 Tattoo: BSF9 W228

Birth: 3-15-09

Beckton Clifftop T C075
 BJR Topper 5241
 Beckton Barmaid A761 TR
BKT CLIFFTOP TP R288
 Ref. B-1
 Beckton Christy K209 CO
 Beckton Copper JT G095
 Beckton Christy A111 VQ
 Beckton Julian GG B571
 Beckton Julian 7526G
 Bkt Marta 9A13 JL
BKT SUFFEINA J755 JL
 Bkt Suffeina A828 DM
 Beckton Dominor 9455
 Bkt Suffeina 9493 TT

DAM		Calv.Ease	BW	WW	YW	Milk	HPG	Stay	Maint.En.
Age	10	12	-2.1	25	54	15	10	16	-5.1
Wt	1070								
Prog.BW	74								
WR	100			Marb +0.03	REA +0.35			Bfat +0.01	
YR	100								
Wean Pct.	57%								
Cow Eff.	121								
BWt	WWt	WR	ADG	YWt	YR	Scr.	Fr.		
81	614	103	4.87	1108	104	38	5.0		

★★★★★ for Low Maintenance, Gainability, Rib-eye area, High Cow Efficiency, Calving Ease, Stayability. Selling 1/2 Interest & Full Possession.

• Bulls •

91 BECKTON EPITOMY W342

1-A 100% # 1332035 Tattoo: BKT9 W342

Birth: 3-21-09

Beckton Epic K4 N795
 Beckton Epic KJ J722
 Beckton Sierra J789 EP

BECKTON EPITOMY S250
 Ref. E-3
 Beckton Tara M635 JL
 Beckton Julian GG B571
 Beckton Tara J266 HR
 Beckton Lancer T A664

MRM Lancer 916
 Beckton Lancer T3 J396

BECKTON SUSAN L258 LR
 Beckton Susan F315 TP
 RDD B Topper 1675
 Beckton Susan 9785VK

DAM		Calv.Ease	BW	WW	YW	Milk	HPG	Stay	Maint.En.
Age	8	13	-3.7	19	47	16	7	14	-4.7
Wt	1015								
Prog.BW	62								
WR	104			Marb +.12	REA +.12		Bfat +.01		
YR	99								
Wean Pct.	62%	BWt	WWt	WR	ADG	YWt	YR	Scr.	Fr.
Cow Eff.	130	73	624	105	3.87	1112	104	37	5.0

★★★★★ for Low Maintenance, Marbling, High Cow Efficiency, Calving Ease, Stayability.

93 BECKTON NEBULA W540 L2

1-A 100% # 1331681 Tattoo: BSF9 W540

Birth: 3-31-09

Beckton Neptune R2 K065
 Beckton Neptune RR B284
 Beckton Lana C735 TP

BECKTON NEBULA M045
 Ref. N-1
 Beckton Belga K285 JL
 Beckton Julian GG B571
 Beckton Belga G493 HR
 Beckton Lancer TL G626
 Beckton Angel G356 HR

Beckton Lancer T3 J396
 Beckton Lancer TS D390
 Beckton Lana D550 CB

DAM		Calv.Ease	BW	WW	YW	Milk	HPG	Stay	Maint.En.
Age	7	19	-8.2	20	50	16	11	12	-6.5
Wt	1095								
Prog.BW	61								
WR	108			Marb +.07	REA +.05		Bfat +.00		
YR	107								
Wean Pct.	58%	BWt	WWt	WR	ADG	YWt	YR	Scr.	Fr.
Cow Eff.	122	57	635	109	4.01	1115	104	36	5.0

★★★★★ for Low Maintenance, Gainability, Superior Cow, High Cow Efficiency, Calving Ease.

92 BECKTON NEBULA W163 J4

1-A 100% # 1332446 Tattoo: BKT9 W163

Birth: 3-11-09

Beckton Nebula L P093
 Beckton Nebula M045
 Beckton Marta M021 LN

BECKTON NEBULA T398 V3
 Ref. N-11
 Beckton Minerva J615 VG
 Beckton Vegas PK F485
 Beckton Minerva F433 VG

Beckton Julian G3 P608
 Beckton Julian GG B571
 Bkt Suffeina A828 DM

BECKTON LANA T570 JL
 Beckton Lana M793 LO
 Beckton Loki F251
 Beckton Lana G056 CO

DAM		Calv.Ease	BW	WW	YW	Milk	HPG	Stay	Maint.En.
Age	2	11	-2.1	33	71	15	9	16	-6.1
Wt	855								
Prog.BW	68								
WR	113			Marb +.17	REA +.07		Bfat +.00		
YR	110								
Wean Pct.	62%	BWt	WWt	WR	ADG	YWt	YR	Scr.	Fr.
Cow Eff.	130	68	589	113	3.92	1108	110	32	5.0

★★★★★ for Low Maintenance, Growth, Marbling, Superior Cow, High Cow Efficiency, Calving Ease, Stayability. Selling ½ Interest & Full Possession.

94 BECKTON ACTION W024 E2

1-A 100% # 1332403 Tattoo: BKT9 W024

Birth: 2-22-09

Beckton Cody K2 R168
 Beckton Cody KH M390
 Beckton Tamara K249 VG

BECKTON ACTION T061 D1
 Ref. C-2
 Beckton Belga R716 DM
 Beckton Dominor ZC M919
 Beckton Belga K285 JL

Beckton Epic K4 N795
 Beckton Epic KJ J722
 Beckton Sierra J789 EP

BECKTON SCARLET T401 EP
 Beckton Scarlet M649 DM
 Beckton Dominor Z E401
 Beckton Scarlet G418 WR

DAM		Calv.Ease	BW	WW	YW	Milk	HPG	Stay	Maint.En.
Age	2	8	0.4	38	83	16	9	14	3.6
Wt	855								
Prog.BW	74								
WR	105			Marb +.05	REA +.19		Bfat +.01		
YR	106								
Wean Pct.	59%	BWt	WWt	WR	ADG	YWt	YR	Scr.	Fr.
Cow Eff.	123	74	561	105	4.01	1047	106	34	5.0

★★★★★ for Low Maintenance, Growth, Gainability, Rib-eye area, Superior Cow, High Cow Efficiency, Calving Ease, Stayability.



95 BECKTON RANGER W105 E4

1-A 100% # 1332459 Tattoo: BKT9 W105

Birth: 3-5-09

Beckton Ranger 9479R
 Beckton Ranger 7003
 Beckton Eola 7470 RZ

BECKTON RANGER T603 H3
 Ref. R-1
 Beckton Rose N044 HU
 Beckton Hustler C2 L079
 Beckton Rose L669 JL

Beckton Epic KM M115
 Beckton Epic K F075
 Beckton Minerva F495 CH

BECKTON BARMAID T645 EP
 Beckton Barmaid P030 EP
 Beckton Epic K3 M606
 Beckton Barmaid M782 LN

DAM		Calv.Ease	BW	WW	YW	Milk	HPG	Stay	Maint.En.
Age	2	12	-4.3	27	61	15	9	12	-6.6
Wt	800								
Prog.BW	58								
WR	114			Marb +.14	REA -.05		Bfat +.01		
YR	109								
Wean Pct.	68%	BWt	WWt	WR	ADG	YWt	YR	Scr.	Fr.
Cow Eff.	144	58	607	114	3.60	1072	109	35	5.5

★★★★★ for Low Maintenance, Growth, Marbling, Superior Cow, High Cow Efficiency, Calving Ease.

• Bulls •

96 BECKTON JULIAN W218 H5
1-A 100% # 1331727 Tattoo: BSF9 W218

Birth: 3-15-09
 Beckton Julian GG B571
BECKTON JULIAN G3 P608
 Ref. J-3
 Beckton Sufaina A828 DM
 Beckton Herald FJ J776
BECKTON LARKABEL N769 HR
 Beckton Larkabel F246 CT
 Beckton Julian 7526G
 Bkt Marta 9A13 JL
 Beckton Dominor 9455
 Bkt Sufaina 9493 TT
 Beckton Herald F FA20
 Bkt Larkeisa D095 JL
 Beckton Clifftop T C075
 Bkt Larkabel B012 CB

DAM		Calv.Ease	BW	WW	YW	Milk	HPG	Stay	Maint.En.
Age	6	17	-5.2	22	53	14	13	15	-5.4
Wt	1000								
Prog.BW	64								
WR	99								
YR	101								
Wean Pct.	59%								
Cow Eff.	123								
		Marb +.08			REA +.05		Bfat +.01		
		BWt	WWt	WR	ADG	YWt	YR	Scr.	Fr.
		67	585	101	4.10	1131	106	32	5.0

★★★★★ for Low Maintenance, Gainability, High Cow Efficiency, Calving Ease, Stayability.

99 BECKTON NEBULA W168 E4
1-A 100% # 1332445 Tattoo: BKT9 W168

Birth: 3-11-09
 Beckton Nebula L P093
BECKTON NEBULA T398 V3
 Ref. N-11
 Beckton Minerva J615 VG
 Beckton Epic K3 M606
BECKTON EOLA T565 EP
 Beckton Eola N072 WR
 Beckton Nebula M045
 Beckton Marta M021 LN
 Beckton Vegas PK F485
 Beckton Minerva F433 VG
 Beckton Epic KJ J722
 Beckton Lana F268 CT
 Beckton Warrior TD L493
 Beckton Eola L544 WR

DAM		Calv.Ease	BW	WW	YW	Milk	HPG	Stay	Maint.En.
Age	2	9	-1.4	31	71	12	7	12	-3.7
Wt	850								
Prog.BW	66								
WR	105								
YR	110								
Wean Pct.	57%								
Cow Eff.	121								
		Marb +.05			REA +.15		Bfat -.01		
		BWt	WWt	WR	ADG	YWt	YR	Scr.	Fr.
		66	548	105	4.01	1103	110	38	5.0

★★★★★ for Low Maintenance, Growth, Gainability, Rib-eye area, Superior Cow, High Cow Efficiency, Calving Ease.

97 BECKTON HERITAGE W054 J3
1-A 100% # 1332371 Tattoo: BKT9 W054

Birth: 2-26-09
 Beckton Heritage N013
BECKTON HERITAGE T270 J2
 Ref. H-3
 Beckton Coca P602 JL
 Beckton Julian G3 P608
BECKTON CHRISTY T275 JL
 Beckton Christy C306 JL
 Beckton Hustler C2 L079
 Beckton Lana L007 JL
 Beckton Julian GG B571
 Beckton Coca J270 CD
 Beckton Julian GG B571
 Bkt Sufaina A828 DM
 Beckton Julian 7526G
 Beckton Christy Z264 NP

DAM		Calv.Ease	BW	WW	YW	Milk	HPG	Stay	Maint.En.
Age	2	14	-2.2	35	61	14	12	17	-5.9
Wt	810								
Prog.BW	75								
WR	112								
YR	99								
Wean Pct.	66%								
Cow Eff.	139								
		Marb +.16			REA +.10		Bfat +.00		
		BWt	WWt	WR	ADG	YWt	YR	Scr.	Fr.
		75	596	112	2.57	979	99	35	5.5

★★★★★ for Low Maintenance, Marbling, High Cow Efficiency, Calving Ease, Stayability.



98 BECKTON EMCEE W252 J2
1-A 100% # 1331750 Tattoo: BSF9 W252

Birth: 3-17-09
 Beckton Epic K4 N795
BECKTON EMCEE S466
 Ref. E-4
 Beckton Larkaba H798 WR
 Beckton Julio L233
BECKTON ROSE P376 JO
 Beckton Rose J565 CO
 Beckton Epic KJ J722
 Beckton Sierra J789 EP
 Beckton Warrior T C371
 Beckton Larkaba E042 CD
 Beckton Julian G1 J526
 Beckton Rose J725 EP
 Beckton Copper J E616
 Beckton Rose F280 JL

DAM		Calv.Ease	BW	WW	YW	Milk	HPG	Stay	Maint.En.
Age	5	11	-2.8	26	47	17	4	14	0.6
Wt	1080								
Prog.BW	77								
WR	101								
YR	103								
Wean Pct.	53%								
Cow Eff.	111								
		Marb +.12			REA -.06		Bfat +.01		
		BWt	WWt	WR	ADG	YWt	YR	Scr.	Fr.
		75	570	98	3.24	977	91	35	5.0

★★★★★ for Low Maintenance, Marbling, Calving Ease, Stayability.

100 BECKTON JUSTICE W784 E5
1-A 100% # 1331643 Tattoo: BSF9 W784

Birth: 4-21-09
 Beckton Justice CH M056
BECKTON JUSTICE C1 R483
 Ref. J-4
 Beckton Tamara J124 HR
 Beckton Epic D404
BECKTON LANA K237 EP
 Beckton Lana CB29 JL
 Beckton Justice C K449
 Beckton Ruth K802 HD
 Beckton Herald F FA20
 Beckton Tamara F183 CT
 Beckton Saga KJ B702
 Beckton Kuruba B508 PC
 Beckton Julian 8970S
 Beckton Lana 7600 PN

DAM		Calv.Ease	BW	WW	YW	Milk	HPG	Stay	Maint.En.
Age	NA	13	-3.9	20	53	14	10	13	-4.1
Wt	1095								
Prog.BW	65								
WR	101								
YR	101								
Wean Pct.	57%								
Cow Eff.	119								
		Marb +.00			REA +.05		Bfat +.00		
		BWt	WWt	WR	ADG	YWt	YR	Scr.	Fr.
		73	618	116	4.19	1148	112	36	5.0

★★★★★ for Low Maintenance, Gainability, High Cow Efficiency, Calving Ease, Stayability.

• Bulls •

101 BECKTON JULIAN W455 E5
1-A 100% # 1332165 Tattoo: BKT9 W455

Birth: 3-26-09
 Beckton Julian GG B571
BECKTON JULIAN G3 P608
 Ref. J-3
 Bkt Suffeina A828 DM
 Beckton Julian 7526G
 Bkt Marta 9A13 JL
 Beckton Dominor 9455
 Bkt Suffeina 9493 TT
 Beckton Epic K F075
 Beckton Minerva F495 CH
 Beckton Cozad D789
 Beckton Serena D128 NP
BECKTON SERENA R180 EP
 Beckton Epic KM M115
 Beckton Serena F248 CZ

DAM		Calv.Ease	BW	WW	YW	Milk	HPG	Stay	Maint.En.
Age	4	16	-5.9	18	50	18	12	15	-4.5
Wt	990								
Prog.BW	65								
WR	105			Marb +.13	REA -.19			Bfat +.01	
YR	103								
Wean Pct.	57%	BWt	WWt	WR	ADG	YWt	YR	Scr.	Fr.
Cow Eff.	120	67	584	98	3.83	1109	104	35	5.0

★★★★★ for Low Maintenance, Marbling, Superior Cow, High Cow Efficiency, Calving Ease, Stayability.

104 BECKTON NEBULA W476 J3
1-A 100% # 1332286 Tattoo: BKT9 W476

Birth: 3-27-09
 Beckton Nebula M045
BECKTON NEBULA E P084
 Ref. N
 BKT Pine Marie M119 EP
 Beckton Neptune R2 K065
 Beckton Belga K285 JL
 Beckton Epic K F075
 Bkt Pine Marie D126 JL
 Beckton Julian G1 J526
 Beckton Rose J725 EP
BECKTON SIERRA S639 JO
 Beckton Julio L233
 Beckton Sierra L887 LN
 Beckton Lancer TZ D525
 Beckton Sierra H442 HD

DAM		Calv.Ease	BW	WW	YW	Milk	HPG	Stay	Maint.En.
Age	3	16	-5.3	20	45	14	9	16	-9.4
Wt	1120								
Prog.BW	68								
WR	106			Marb +.20	REA +.07			Bfat +.01	
YR	103								
Wean Pct.	47%	BWt	WWt	WR	ADG	YWt	YR	Scr.	Fr.
Cow Eff.	99	68	564	106	3.60	1058	103	38	5.0

★★★★★ for Low Maintenance, Marbling, Calving Ease, Stayability.

102 BECKTON EPIC W690 C4
1-A 100% # 1332304 Tattoo: BKT9 W690

Birth: 4-12-09
 Beckton Epic K F075
BECKTON EPIC R350 K
 Ref. E-2
 Beckton Larkaba E042 CD
 Beckton Epic D404
 Beckton Belga D483 KR
 Beckton Cody C401
 Beckton Larkaba C317 CL
 Bkt Clifftop TV G672
 Beckton Lana J384 CD
 Beckton Herald FN K641
 Beckton Serena K594 HR
BECKTON SERENA S819 CT
 Beckton Clifftop T3 N800
 Beckton Serena M036 HR

DAM		Calv.Ease	BW	WW	YW	Milk	HPG	Stay	Maint.En.
Age	3	10	-1.4	30	63	18	9	10	2.2
Wt	910								
Prog.BW	74								
WR	106			Marb +.11	REA -.04			Bfat +.01	
YR	103								
Wean Pct.	64%	BWt	WWt	WR	ADG	YWt	YR	Scr.	Fr.
Cow Eff.	135	76	622	109	3.74	1118	107	37	5.5

★★★★★ for Low Maintenance, Growth, Marbling, High Cow Efficiency, Calving Ease.

105 BECKTON DOMINOR W777 J5
1-A 100% # 1332100 Tattoo: BKT9 W777

Birth: 4-20-09
 Beckton Dominor ZC M919
BECKTON DOMINOR Z1 R610
 Ref. D-1
 Beckton Sierra K557 LO
 Beckton Dominor Z E401
 Beckton Barmaid J012 CO
 Beckton Loki F251
 Beckton Sierra C157 CL
 Beckton Julian GG B571
 Beckton Annie F743 LN
BECKTON LANA N664 JL
 Beckton Julian G1 J526
 Beckton Lana H533 LN
 Beckton Lancer TS D390
 Beckton Lana D466 NM

DAM		Calv.Ease	BW	WW	YW	Milk	HPG	Stay	Maint.En.
Age	6	16	-6.5	28	60	20	6	16	-2.7
Wt	1115								
Prog.BW	71								
WR	109			Marb +.08	REA +.13			Bfat +.00	
YR	102								
Wean Pct.	55%	BWt	WWt	WR	ADG	YWt	YR	Scr.	Fr.
Cow Eff.	116	64	615	103	3.42	1093	102	34	5.0

★★★★★ for Low Maintenance, Rib-eye area, High Cow Efficiency, Calving Ease, Stayability.

103 BECKTON NEBULA W339 J3
1-A 100% # 1331740 Tattoo: BSF9 W339

Birth: 3-21-09
 Beckton Nebula M045
BECKTON NEBULA H R233
 Ref. N-4
 Beckton Coca H132 HD
 Beckton Neptune R2 K065
 Beckton Belga K285 JL
 Beckton Hadrian F C486
 Beckton Coca CB74 JV
 Beckton Justice C K449
 Beckton Ruth K802 HD
 Bkt Javelin 7466 R
 Beckton Lana K346 CO
BECKTON LANA P159 JC
 Beckton Justice CH M056
 Beckton Lana M199 JV

DAM		Calv.Ease	BW	WW	YW	Milk	HPG	Stay	Maint.En.
Age	5	18	-7.1	14	41	13	14	13	-9.1
Wt	935								
Prog.BW	58								
WR	99			Marb +.08	REA +.00			Bfat -.01	
YR	98								
Wean Pct.	58%	BWt	WWt	WR	ADG	YWt	YR	Scr.	Fr.
Cow Eff.	122	57	540	91	3.87	1049	99	35	5.0

★★★★★ for Low Maintenance, High Cow Efficiency, Calving Ease, Stayability.

106 BECKTON EPITOMY W358 C2
1-A 100% # 1331993 Tattoo: BKT9 W358

Birth: 3-22-09
 Beckton Epic K4 N795
BECKTON EPITOMY S250
 Ref. E-3
 Beckton Tara M635 JL
 Beckton Epic KJ J722
 Beckton Sierra J789 EP
 Beckton Julian GG B571
 Beckton Tara J266 HR
 BJR Topper 5241
 Beckton Barmaid A761 TR
BECKTON COCA F370 CT
 Beckton Clifftop T C075
 Beckton Coca C178 VG
 Beckton Vegas 9433
 Beckton Coca 8372 TJ

DAM		Calv.Ease	BW	WW	YW	Milk	HPG	Stay	Maint.En.
Age	13	13	-3.2	19	49	11	8	14	-1.9
Wt	1115								
Prog.BW	67								
WR	99			Marb +.00	REA +.28			Bfat -.01	
YR	101								
Wean Pct.	47%	BWt	WWt	WR	ADG	YWt	YR	Scr.	Fr.
Cow Eff.	99	70	544	91	3.74	1056	99	34	5.0

★★★★★ for Low Maintenance, Rib-eye area, Calving Ease, Stayability.

• Bulls •



109 BECKTON NEBULA W529 E3
1-A 100% # 1331933 Tattoo: BSF9 W529

Birth: 3-30-09
 Beckton Nebula M045
 Beckton Neptune R2 K065
 Beckton Belga K285 JL
BECKTON NEBULA L P093
 Ref. N-2
 Beckton Marta M021 LN
 Beckton Lancer TA K644
 Beckton Marta K254 LN
 Beckton Exeter R090
 Beckton Epic K4 N795
BECKTON ROSE T027 EX
 Beckton Rose R882 JL
 Beckton Lana N310 EP
 Beckton Julian G1 J526
 Beckton Rose G345 JL

DAM		Calv.Ease	BW	WW	YW	Milk	HPG	Stay	Maint.En.
Age	2	12	-1.4	37	75	6	11	16	-2.2
Wt	800								
Prog.BW	69								
WR	108								
YR	106								
Wean Pct.	64%								
Cow Eff.	135								
		Marb			REA		Bfat		
		BWt	WWt	WR	ADG	YWt	YR	Scr.	Fr.
		69	574	108	3.24	1051	106	36	5.5

★★★★★ for Low Maintenance, Growth, Marbling, Rib-eye area, Superior Cow, High Cow Efficiency, Calving Ease, Stayability.

107 BECKTON NEBULA W592 L4
1-A 100% # 1331875 Tattoo: BSF9 W592

Birth: 4-3-09
 Beckton Nebula E P084
 Beckton Nebula M045
 BKT Pine Marie M119 EP
BECKTON NEBULA EN S347
 Ref. N-7
 Beckton Eola P530 NB
 Beckton Nebula M045
 Beckton Eola M663 EP
 Beckton Loki C M740
 Beckton Loki F251
 BKT Larkeisa J051 CK
BECKTON ROSE S307 LO
 Beckton Rose N607 CO
 Beckton Copper JT G095
 Beckton Rose J725 EP

DAM		Calv.Ease	BW	WW	YW	Milk	HPG	Stay	Maint.En.
Age	3	15	-6.1	21	52	14	10	17	-5.5
Wt	940								
Prog.BW	60								
WR	103								
YR	103								
Wean Pct.	58%								
Cow Eff.	122								
		Marb			REA		Bfat		
		BWt	WWt	WR	ADG	YWt	YR	Scr.	Fr.
		64	584	104	3.65	1059	103	35	5.5

★★★★★ for Low Maintenance, Marbling, High Cow Efficiency, Calving Ease, Stayability.

110 BECKTON JUSTICE W466 E5
1-A 100% # 1331897 Tattoo: BSF9 W466

Birth: 3-27-09
 Beckton Justice CH M056
 Beckton Justice C K449
 Beckton Ruth K802 HD
BECKTON JUSTICE C1 R483
 Ref. J-4
 Beckton Tamara J124 HR
 Beckton Herald F FA20
 Beckton Tamara F183 CT
 Beckton Epic K F075
 Beckton Epic D404
 Beckton Belga D483 KR
BKT SUFFEINA S517 EP
 Bkt Suffeina A828 DM
 Beckton Dominor 9455
 Bkt Suffeina 9493 TT

DAM		Calv.Ease	BW	WW	YW	Milk	HPG	Stay	Maint.En.
Age	3	11	-3.0	27	59	15	10	14	-2.4
Wt	930								
Prog.BW	73								
WR	96								
YR	98								
Wean Pct.	56%								
Cow Eff.	117								
		Marb			REA		Bfat		
		BWt	WWt	WR	ADG	YWt	YR	Scr.	Fr.
		69	559	99	3.47	1026	100	35	5.5

★★★★★ for Low Maintenance, High Cow Efficiency, Calving Ease, Stayability.

108 BECKTON DOMINOR W633 L5
1-A 100% # 1332268 Tattoo: BKT9 W633

Birth: 4-6-09
 Beckton Dominor ZC M919
 Beckton Dominor Z E401
 Beckton Barmaid J012 CO
BECKTON DOMINOR Z1 R610
 Ref. D-1
 Beckton Sierra K557 LO
 Beckton Loki F251
 Beckton Sierra C157 CL
 Beckton Lancer F442 T
 Beckton Lancer T A664
 Bkt Suffeina A828 DM
BECKTON KIT S478 LN
 Beckton Kit F468 JL
 Beckton Julian GG B571
 Beckton Kit A517 NP

DAM		Calv.Ease	BW	WW	YW	Milk	HPG	Stay	Maint.En.
Age	3	14	-3.3	31	63	17	7	16	-2.2
Wt	1020								
Prog.BW	67								
WR	103								
YR	103								
Wean Pct.	53%								
Cow Eff.	112								
		Marb			REA		Bfat		
		BWt	WWt	WR	ADG	YWt	YR	Scr.	Fr.
		66	581	106	3.60	1060	102	35	5.5

★★★★★ for Low Maintenance, Marbling, Rib-eye area, Calving Ease, Stayability.

111 BECKTON ROMAN W835
1-A 100% # 1332107 Tattoo: BKT9 W835

Birth: 4-28-09
 TR Romeo NT379
 Buffalo Creek Romeo L081
 Buf Crk Lass L420
BECKTON ROMAN J S158
 Ref. J-6
 Beckton Belga K285 JL
 Beckton Julian GG B571
 Beckton Belga G493 HR
 Beckton Lancer T7 M089
 Beckton Lancer F442 T
 Beckton Tamara G141 HE
BECKTON ROSE P015 LN
 Beckton Rose M131 HR
 Beckton Herald HH E503
 Beckton Rose H253 CH

DAM		Calv.Ease	BW	WW	YW	Milk	HPG	Stay	Maint.En.
Age	5	11	-1.8	35	69	18	8	12	-4.1
Wt	1000								
Prog.BW	69								
WR	104								
YR	101								
Wean Pct.	62%								
Cow Eff.	130								
		Marb			REA		Bfat		
		BWt	WWt	WR	ADG	YWt	YR	Scr.	Fr.
		74	619	104	3.20	1087	102	37	5.0

★★★★★ for Low Maintenance, Rib-eye area, High Cow Efficiency, Calving Ease.

• Bulls •

112 BECKTON DOMINOR W173 K5

1-A 100% # 1331599 Tattoo: BSF9 W173

Birth: 3-12-09

Beckton Dominor ZC M919
 Beckton Dominor Z E401
 Beckton Barmaid J012 CO

BECKTON DOMINOR Z1 R610
 Ref. D-1
 Beckton Sierra K557 LO
 Beckton Loki F251
 Beckton Sierra C157 CL

Beckton Kannon D202
 Beckton Julian GV Z693
 Bkt Larkeisa 9801 LS

BECKTON RUTH F125 KA
 Beckton Ruth D247 KR
 Beckton Kaiser FD 9253
 Beckton Ruth A137 CL

DAM		Calv.Ease	BW	WW	YW	Milk	HPG	Stay	Maint.En.
Age	13	14	-5.1	21	44	16	6	15	0.1
Wt	1090								
Prog.BW	73								
WR	97								
YR	99								
Wean Pct.	46%								
Cow Eff.	98								
		Marb			REA			Bfat	
		BWt	WWt	WR	ADG	YWt	YR	Scr.	Fr.
		59	525	88	4.10	992	93	36	5.0

★★★★★ for Low Maintenance, Gainability, Calving Ease, Stayability.

114 BSF EPIC W396 J4

1-B 99% # 1331837 Tattoo: BSF9 W396

Birth: 3-23-09

Beckton Epic K F075
 Beckton Epic D404
 Beckton Belga D483 KR

BECKTON EPIC R350 K
 Ref. E-2
 Beckton Larkaba E042 CD
 Beckton Cody C401
 Beckton Larkaba C317 CL

Beckton Justice CH M056
 Beckton Justice C K449
 Beckton Ruth K802 HD

BSF JUSTICIA R874 JC
 BSF Regus M411 EP
 Beckton Epic KJ J722
 BSF Regus H012

DAM		Calv.Ease	BW	WW	YW	Milk	HPG	Stay	Maint.En.
Age	4	14	-4.3	26	56	18	9	12	-0.5
Wt	975								
Prog.BW	56								
WR	105								
YR	103								
Wean Pct.	66%								
Cow Eff.	138								
		Marb			REA			Bfat	
		BWt	WWt	WR	ADG	YWt	YR	Scr.	Fr.
		64	659	111	3.24	1112	105	39	5.0

★★★★★ for Low Maintenance, Marbling, High Cow Efficiency, Calving Ease.

113 BECKTON HASTEN W669 L3

1-A 100% # 1332021 Tattoo: BKT9 W669

Birth: 4-9-09

Beckton Hasten P292
 Beckton Hustler C2 L079
 Beckton Sheba L644 CH

BECKTON HASTEN H S462
 Ref. H-2
 Beckton Lakme G128 HD
 Beckton Hadrian FC E166
 Beckton Lakme E373 CL

Beckton Lancer T A664
 Beckton Lancer 9380
 Beckton Coca 9119 TJ

BECKTON BELGA K202 LN
 Beckton Belga D460 KR
 Beckton Kaiser FD 9253
 Beckton Belga A573 SC

DAM		Calv.Ease	BW	WW	YW	Milk	HPG	Stay	Maint.En.
Age	NA	19	-7.8	21	51	16	8	12	-0.6
Wt	1170								
Prog.BW	59								
WR	98								
YR	100								
Wean Pct.	50%								
Cow Eff.	105								
		Marb			REA			Bfat	
		BWt	WWt	WR	ADG	YWt	YR	Scr.	Fr.
		55	583	109	3.65	1032	100	36	5.0

★★★★★ for Low Maintenance, Calving Ease.

115 BSF EPITOMY W114 N2

1-B 99% # 1331786 Tattoo: BSF9 W114

Birth: 3-6-09

Beckton Epic K4 N795
 Beckton Epic KJ J722
 Beckton Sierra J789 EP

BECKTON EPITOMY S250
 Ref. E-3
 Beckton Tara M635 JL
 Beckton Julian GG B571
 Beckton Tara J266 HR

Beckton Nebula M045
 Beckton Neptune R2 K065
 Beckton Belga K285 JL

BSF NEBULANN R163 NB
 BSF Regus F175
 Beckton Vegas P D462
 Bkt Regus D034

DAM		Calv.Ease	BW	WW	YW	Milk	HPG	Stay	Maint.En.
Age	4	13	-3.5	22	54	13	11	14	-5.1
Wt	920								
Prog.BW	64								
WR	101								
YR	103								
Wean Pct.	61%								
Cow Eff.	128								
		Marb			REA			Bfat	
		BWt	WWt	WR	ADG	YWt	YR	Scr.	Fr.
		73	578	100	3.60	1074	100	38	5.0

★★★★★ for Low Maintenance, Marbling, Rib-eye area, High Cow Efficiency, Calving Ease, Stayability.



116 BSF HASTEN W660 J3

1-B 99% # 1331779 Tattoo: BSF9 W660

Birth: 4-9-09

Beckton Hasten P292
 Beckton Hustler C2 L079
 Beckton Sheba L644 CH

BECKTON HASTEN H S462
 Ref. H-2
 Beckton Lakme G128 HD
 Beckton Hadrian FC E166
 Beckton Lakme E373 CL

Beckton Juno N493
 Beckton Julian G1 J526
 Beckton Serena D760 KR

BSF LAUREL R107 JJ
 BSF Laurel N239 LN
 Beckton Lancer T4 J536
 BSF Regus F071

DAM		Calv.Ease	BW	WW	YW	Milk	HPG	Stay	Maint.En.
Age	4	14	-5.0	34	66	16	5	13	4.0
Wt	1115								
Prog.BW	68								
WR	106								
YR	112								
Wean Pct.	54%								
Cow Eff.	113								
		Marb			REA			Bfat	
		BWt	WWt	WR	ADG	YWt	YR	Scr.	Fr.
		69	620	104	3.92	1117	105	35	5.5

★★★★★ for Low Maintenance, Growth, Superior Cow, Calving Ease, Stayability.

• Bulls •

117 **BSF EPIC W517 J4**
1-B 99% # 1331730 Tattoo: BSF9 W517

Birth: 3-29-09
 Beckton Epic K F075
BECKTON EPIC R350 K
 Ref. E-2
 Beckton Larkaba E042 CD
 Beckton Epic D404
 Beckton Belga D483 KR
 Beckton Cody C401
 Beckton Larkaba C317 CL
 Beckton Justice C K449
 Beckton Ruth K802 HD
 Beckton Herald FN K641
 BSF Regus K745 CT
 Beckton Justice CH M056
BSF JUSTICIA P007
 BSF Regus M024 HR

DAM		Calv.Ease	BW	WW	YW	Milk	HPG	Stay	Maint.En.
Age	5	14	-4.7	26	53	16	10	11	-0.6
Wt	1065	Marb +0.09			REA +0.05		Bfat +0.01		
Prog.BW	62	BWt	WWt	WR	ADG	YWt	YR	Scr.	Fr.
WR	101	59	638	110	3.33	1080	101	34	5.0
YR	99								
Wean Pct.	60%								
Cow Eff.	126								

★★★★★ for Low Maintenance, High Cow Efficiency, Calving Ease.

120 **BSF JULIAN W681 E5**
1-B 99% # 1331852 Tattoo: BSF9 W681

Birth: 4-11-09
 Beckton Julian GG B571
BECKTON JULIAN G3 P608
 Ref. J-3
 Bkt Suffeina A828 DM
 Beckton Julian 7526G
 Bkt Marta 9A13 JL
 Beckton Dominor 9455
 Bkt Suffeina 9493 TT
 Beckton Epic K F075
 BKT Larkeisa L274 HU
 Beckton Julian G2 M345
 BSF Regus M352 CD
 Beckton Epic KH P678
BSF JULIANNE S109 EP
 BSF Julianne P152

DAM		Calv.Ease	BW	WW	YW	Milk	HPG	Stay	Maint.En.
Age	3	17	-6.2	21	57	18	11	16	-6.5
Wt	785	Marb +0.14			REA +0.08		Bfat +0.01		
Prog.BW	61	BWt	WWt	WR	ADG	YWt	YR	Scr.	Fr.
WR	111	60	609	108	3.92	1131	110	39	5.0
YR	105								
Wean Pct.	73%								
Cow Eff.	153								

★★★★★ for Low Maintenance, Marbling, Superior Cow, High Cow Efficiency, Calving Ease, Stayability.

118 **BSF EMPEROR W116 C3**
1-B 99% # 1331974 Tattoo: BSF9 W116

Birth: 3-6-09
 Beckton Emperor R100
BECKTON EMPEROR T641 E2
 Ref. E-6
 Beckton Vernice R416 EP
 Beckton Epic K4 N795
 Beckton Tamara N180 JO
 Beckton Epic K3 M606
 Beckton Vernice K482 HD
 Bkt Clifftop TV G672
 Beckton Lana J384 CD
 Beckton Nebula M045
 BSF Regus M717 EP
 Beckton Clifftop T3 N800
BSF NEBULANN T682 CT
 BSF Nebulann P046

DAM		Calv.Ease	BW	WW	YW	Milk	HPG	Stay	Maint.En.
Age	2	12	-3.7	24	57	15	8	14	-3.0
Wt	785	Marb +0.12			REA +0.20		Bfat +0.00		
Prog.BW	56	BWt	WWt	WR	ADG	YWt	YR	Scr.	Fr.
WR	100	56	537	100	3.65	1027	104	33	5.0
YR	104								
Wean Pct.	61%								
Cow Eff.	128								

★★★★★ for Low Maintenance, Marbling, Rib-eye area, High Cow Efficiency, Calving Ease, Stayability.



119 **BSF NEBULA W087 J4**
1-B 99% # 1331978 Tattoo: BSF9 W087

Birth: 3-3-09
 Beckton Nebula L P093
BECKTON NEBULA T398 V3
 Ref. N-11
 Beckton Minerva J615 VG
 Beckton Nebula M045
 Beckton Marta M021 LN
 Beckton Vegas PK F485
 Beckton Minerva F433 VG
 Beckton Julian GG B571
 Bkt Suffeina A828 DM
 Beckton Lancer T4 J536
 BSF Regus F697
 Beckton Julian G3 P608
BSF LANETTE T781 JL
 BSF Lanette P615

DAM		Calv.Ease	BW	WW	YW	Milk	HPG	Stay	Maint.En.
Age	2	11	-1.3	36	71	14	10	16	-1.8
Wt	885	Marb +0.04			REA +0.08		Bfat -0.01		
Prog.BW	69	BWt	WWt	WR	ADG	YWt	YR	Scr.	Fr.
WR	111	69	594	111	3.47	1055	107	35	5.0
YR	107								
Wean Pct.	60%								
Cow Eff.	127								

★★★★★ for Low Maintenance, Growth, Superior Cow, High Cow Efficiency, Calving Ease, Stayability.

121 **BSF CLIFFTOP W349 L3**
1-B 99% # 1331741 Tattoo: BSF9 W349

Birth: 3-21-09
 Beckton Clifftop T C075
BKT CLIFFTOP TP R288
 Ref. B-1
 Beckton Christy K209 CO
 BJR Topper 5241
 Beckton Barmaid A761 TR
 Beckton Copper JT G095
 Beckton Christy A111 VQ
 Beckton Lancer TL G626
 Beckton Lana C735 TP
 Beckton Champ R3 H338
 BSF Regus J306
 Beckton Lancer T6 M467
BSF LANETTE P177
 BSF Regus M383 CH

DAM		Calv.Ease	BW	WW	YW	Milk	HPG	Stay	Maint.En.
Age	5	13	-5.2	19	44	18	6	13	-4.8
Wt	1000	Marb +0.03			REA +0.08		Bfat -0.01		
Prog.BW	64	BWt	WWt	WR	ADG	YWt	YR	Scr.	Fr.
WR	107	69	621	104	3.65	1047	99	37	5.0
YR	105								
Wean Pct.	62%								
Cow Eff.	131								

★★★★★ for Low Maintenance, Superior Cow, High Cow Efficiency, Calving Ease, Stayability.

• Bulls •

122 BSF EPITOMY W676 J2

1-B 99% # 1331817 Tattoo: BSF9 W676

Birth: 4-11-09

Beckton Epic K4 N795
 Beckton Epic KJ J722
 Beckton Sierra J789 EP

BECKTON EPITOMY S250
 Ref. E-3
 Beckton Tara M635 JL
 Beckton Julian GG B571
 Beckton Tara J266 HR

Beckton Jules L429
 Beckton Julian G1 J526
 Beckton Barona J591 EP

BSF JULESTE R644 JE
 Beckton Dominor S B431
 BSF Regus D616
 BSF Regus B319

DAM		Calv.Ease	BW	WW	YW	Milk	HPG	Stay	Maint.En.
Age	4	14	-4.3	25	55	17	9	14	-0.3
Wt	1050								
Prog.BW	68								
WR	110								
YR	107								
Wean Pct.	58%								
Cow Eff.	123								
		Marb	+0.16		REA	+0.10		Bfat	+0.02
		BWt	WWt	WR	ADG	YWt	YR	Scr.	Fr.
		67	631	106	2.88	1076	101	37	5.0

★★★★★ for Low Maintenance, Marbling, Superior Cow, High Cow Efficiency, Calving Ease, Stayability.

125 BSF NEBULA W648 P3

1-2 98% # 1331608 Tattoo: BSF9 W648

Birth: 4-8-09

Beckton Nebula M045
 Beckton Neptune R2 K065
 Beckton Belga K285 JL

BECKTON NEBULA J R475
 Ref. N-5
 Beckton Larkeisa M138 JC
 Beckton Justice G302
 Bkt Larkeisa G448 CT

Beckton Plato C154
 Beckton Julian GR A967
 Bkt PineMarie A927 CL

BSF REGUS G166
 BSF Regus 7237
 BSF Trojan 5226 XM
 BSF Red 3063

DAM		Calv.Ease	BW	WW	YW	Milk	HPG	Stay	Maint.En.
Age	12	14	-3.8	26	50	12	12	14	-6.2
Wt	1190								
Prog.BW	72								
WR	116								
YR	109								
Wean Pct.	53%								
Cow Eff.	111								
		Marb	+0.04		REA	+0.34		Bfat	+0.01
		BWt	WWt	WR	ADG	YWt	YR	Scr.	Fr.
		67	647	109	3.20	1093	102	33	5.0

★★★★★ for Low Maintenance, Rib-eye area, Superior Cow, Calving Ease, Stayability.

123 BSF EPIC W520 E5

1-B 99% # 1331843 Tattoo: BSF9 W520

Birth: 3-29-09

Beckton Epic KJ J722
 Beckton Epic K F075
 Beckton Lana F891 JL

BECKTON EPIC K4 N795
 Ref. E-1
 Beckton Sierra J789 EP
 Beckton Epic D404
 Beckton Sierra C157 CL

Beckton Epic KH P678
 Beckton Epic K F075
 BKT Larkeisa L274 HU

BSF JULIANNE S013 EP
 Beckton Julian G2 M345
 BSF Julianne P332
 BSF Regus M835 JL

DAM		Calv.Ease	BW	WW	YW	Milk	HPG	Stay	Maint.En.
Age	3	8	-0.3	32	75	12	6	15	6.1
Wt	1085								
Prog.BW	69								
WR	94								
YR	97								
Wean Pct.	46%								
Cow Eff.	97								
		Marb	+0.17		REA	+0.06		Bfat	+0.01
		BWt	WWt	WR	ADG	YWt	YR	Scr.	Fr.
		78	538	94	3.83	1044	100	36	5.0

★★★★★ for Marbling, Calving Ease, Stayability.

126 BSF ROMAN W821

1-B 99% # 1331659 Tattoo: BSF9 W821

Birth: 4-25-09

TR Romeo NT379
 Buffalo Creek Romeo L081
 Buf Crk Lass L420

BECKTON ROMAN J S158
 Ref. J-6
 Beckton Belga K285 JL
 Beckton Julian GG B571
 Beckton Belga G493 HR

Beckton Champ R1 H024
 Beckton Champ RH F275
 Beckton Lana F138 LN

BSF REGUS L479 CH
 Beckton Lancer TZ D525
 BSF Regus F205
 BSF Regus D449

DAM		Calv.Ease	BW	WW	YW	Milk	HPG	Stay	Maint.En.
Age	8	11	-0.3	35	63	16	10	16	-1.0
Wt	1130								
Prog.BW	73								
WR	103								
YR	102								
Wean Pct.	50%								
Cow Eff.	105								
		Marb	-0.01		REA	+0.27		Bfat	+0.00
		BWt	WWt	WR	ADG	YWt	YR	Scr.	Fr.
		86	562	95	3.29	1044	98	34	5.5

★★★★★ for Low Maintenance, Rib-eye area, Calving Ease, Stayability.

124 BSF NEBULA W683 J3

1-B 99% # 1331920 Tattoo: BSF9 W683

Birth: 4-11-09

Beckton Nebula M045
 Beckton Neptune R2 K065
 Beckton Belga K285 JL

BECKTON NEBULA L P093
 Ref. N-2
 Beckton Marta M021 LN
 Beckton Lancer TA K644
 Beckton Marta K254 LN

Beckton Justice CH M056
 Beckton Justice C K449
 Beckton Ruth K802 HD

BSF JUSTICIA S777 JC
 Beckton Epic K F075
 BSF Regus L414 EP
 BSF Regus H520

DAM		Calv.Ease	BW	WW	YW	Milk	HPG	Stay	Maint.En.
Age	3	13	-3.3	33	69	9	13	13	-6.4
Wt	900								
Prog.BW	67								
WR	108								
YR	111								
Wean Pct.	63%								
Cow Eff.	133								
		Marb	+0.11		REA	+0.25		Bfat	-0.01
		BWt	WWt	WR	ADG	YWt	YR	Scr.	Fr.
		67	608	110	3.47	1084	104	35	5.5

★★★★★ for Low Maintenance, Marbling, Rib-eye area, Superior Cow, High Cow Efficiency, Calving Ease, Stayability.

127 BSF LOKI W618 J4

1-B 99% # 1331796 Tattoo: BSF9 W618

Birth: 4-5-09

Beckton Loki C M740
 Beckton Loki F251
 BKT Larkeisa J051 CK

BECKTON LOKI CL S284
 Ref. L-2
 Beckton Lakme J460 LT
 Beckton Latigo G714
 Beckton Lakme G128 HD

Beckton Justice CH M056
 Beckton Justice C K449
 Beckton Ruth K802 HD

BSF JUSTICIA R314 JC
 Beckton Champ R1 H024
 BSF Regus K090 CH
 BSF Regus H402

DAM		Calv.Ease	BW	WW	YW	Milk	HPG	Stay	Maint.En.
Age	4	16	-4.8	25	60	13	12	14	1.4
Wt	1095								
Prog.BW	55								
WR	95								
YR	93								
Wean Pct.	51%								
Cow Eff.	107								
		Marb	+0.06		REA	+0.06		Bfat	-0.02
		BWt	WWt	WR	ADG	YWt	YR	Scr.	Fr.
		67	574	97	3.78	1070	101	32	5.0

★★★★★ for Low Maintenance, Calving Ease, Stayability.

• Bulls •



130 **TR JAX WT961**
1-B 97.6% # 1324435 Tattoo: TR2A9 WT96

Birth: 2-28-09
 Beckton Julian GG B571 < BKT Julian 7526 G
 BKT Marta 9A13 JL
TR JULIAN ST630
 Ref. Ms Geometric 003 < BJR Make My Day 981
 Ms Geometric 277
 Beckton Lancer TS D390
TR REGUS MT270
 Beckton Lancer F134 TS < Beckton Tara D565 CB
 Rdd B Topper 1675
 BSF Regus E232 < BSF Red 9425

DAM		Calv.Ease	BW	WW	YW	Milk	HPG	Stay	Maint.En.
Age	7	9	-0.9	27	53	14	10	14	.0
Wt	NA								
Prog.BW	NA								
WR	NA								
YR	NA								
Wean Pct.NA%	NA								
Cow Eff.	NA								
		BWt	WWt	WR	ADG	YWt	YR	Scr.	Fr.
		87	617	104	3.46	1171	104	NA	5.5

★★★★★ for Low Maintenance, Rib-eye area, Calving Ease, Stayability.

128 **BSF NEBULA W374**
1-B 99% # 1331697 Tattoo: BSF9 W374

Birth: 3-22-09
 Beckton Nebula E P084 < Beckton Nebula M045
 BKT Pine Marie M119 EP
BECKTON NEBULA EN S347
 Ref. N-7 < Beckton Eola P530 NB
 Beckton Nebula M045
 Beckton Eola M663 EP
 Andras Pure Gold 132 < Badlands Mr Beef 805
 JHL D5803
BSF ANDREA N061 PG
 BSF Regus L427 HR < Beckton Herald F FA20
 BSF Red G117

DAM		Calv.Ease	BW	WW	YW	Milk	HPG	Stay	Maint.En.
Age	6	15	-4.7	23	36	13	13	12	-9.2
Wt	965								
Prog.BW	66								
WR	98								
YR	91								
Wean Pct.	59%								
Cow Eff.	124								
		BWt	WWt	WR	ADG	YWt	YR	Scr.	Fr.
		74	570	98	2.93	974	91	36	5.0

★★★★★ for Low Maintenance, Marbling, High Cow Efficiency, Calving Ease.

131 **TR NEBULA WT954**
1-A 100% # 1324417 Tattoo: TR2A9 WT95

Birth: 2-16-09
 Beckton Neptune R2 K065 < Beckton Neptune RR B284
 Beckton Lana C735 TP
BECKTON NEBULA M045
 Ref. Beckton Belga K285 JL < Beckton Julian GG B571
 Beckton Belga G493 HR
 BJR Make My Day 981 < BJR Easy Rider 781
 BJR Tow Kana 117-710
MS GEOMETRIC 003
 Ms Geometric 277 < BKT Julian 7526 G
 Ms Geometric 962

DAM		Calv.Ease	BW	WW	YW	Milk	HPG	Stay	Maint.En.
Age	9	14	-5.0	23	60	7	13	10	0.9
Wt	NA								
Prog.BW	NA								
WR	NA								
YR	NA								
Wean Pct.NA%	NA								
Cow Eff.	NA								
		BWt	WWt	WR	ADG	YWt	YR	Scr.	Fr.
		74	519	88	4.04	1165	103	NA	5.5

★★★★★ for Low Maintenance, Gainability, Marbling, Calving Ease.

129 **TR JAX WT969**
1-A 100% # 1324446 Tattoo: TR2A9 WT96

Birth: 2-24-09
 Beckton Julian GG B571 < BKT Julian 7526 G
 BKT Marta 9A13 JL
TR JULIAN ST630
 Ref. Ms Geometric 003 < BJR Make My Day 981
 Ms Geometric 277
 Beckton Cody V E023 < Beckton Cody C401
 Beckton Birdie C353 VG
TR LANA PT460
 Beckton Lana E828 SC < Beckton Scamp 8954
 Beckton Lana B695 SG

DAM		Calv.Ease	BW	WW	YW	Milk	HPG	Stay	Maint.En.
Age	5	16	-4.1	17	52	13	14	12	-1.5
Wt	NA								
Prog.BW	NA								
WR	NA								
YR	NA								
Wean Pct.NA%	NA								
Cow Eff.	NA								
		BWt	WWt	WR	ADG	YWt	YR	Scr.	Fr.
		75	517	87	4.27	1200	107	NA	5.0

★★★★★ for Low Maintenance, Gainability, Marbling, Calving Ease.

132 **TR EPIC WT955**
1-A 100% # 1324428 Tattoo: TR2A9 WT95

Birth: 2-19-09
 Beckton Epic K F075 < Beckton Epic D404
 Beckton Belga D483 KR
TR EPIC ST618
 Ref. Beckton Kit F468 JL < Beckton Julian GG B571
 Beckton Kit A517 NP
 BKT Julian 7526 G < BKT Pine Marie F756 CH
BECKTON CHRISTY L543 JL
 Beckton Christy D409 NM < Beckton Nomad T 9A14
 Beckton Christy Z429 KR

DAM		Calv.Ease	BW	WW	YW	Milk	HPG	Stay	Maint.En.
Age	8	12	-3.7	25	49	14	10	14	0.7
Wt	NA								
Prog.BW	NA								
WR	NA								
YR	NA								
Wean Pct.NA%	NA								
Cow Eff.	NA								
		BWt	WWt	WR	ADG	YWt	YR	Scr.	Fr.
		74	564	95	3.56	1133	101	NA	5.0

★★★★★ for Low Maintenance, Calving Ease, Stayability.

• Bulls •

133 TR NEBULA WT985
1-A 100% # 1324407 Tattoo: TR2A9 WT98

Birth: 1-30-09
 Beckton Neptune R2 K065
BECKTON NEBULA M045
 Ref. Beckton Belga K285 JL
 Beckton Neptune RR B284
 Beckton Lana C735 TP
 Beckton Julian GG B571
 Beckton Belga G493 HR
 Bfck Cherokee Cnyn 4912
 Mars L664 H12 106 Trish
TR BRITTNEY TT702
 Mars Cherokee 106 303
 TR Brittney RT543
 TR Julian LT151
 TR Brittney NT316

DAM		Calv.Ease	BW	WW	YW	Milk	HPG	Stay	Maint.En.
Age	2	15	-4.6	29	58	10	12	14	-3.5
Wt	NA	Marb +.17		REA +.11		Bfat +.01			
Prog.BW	NA	BWt	WWt	WR	ADG	YWt	YR	Scr.	Fr.
WR	NA	60	553	96	3.59	1127	99	NA	5.0
YR	NA								
Wean Pct.	NA%								
Cow Eff.	NA								

★★★★★ for Low Maintenance, Marbling, Calving Ease, Stayability.

135 BECKTON HASTEN W753 J3
1-A 100% # 1331861 Tattoo: BSF9 W753

Birth: 4-18-09
 Beckton Hasten P292
BECKTON HASTEN H S462
 Ref. H-2 Beckton Lakme G128 HD
 Beckton Hustler C2 L079
 Beckton Sheba L644 CH
 Beckton Hadrian FC E166
 Beckton Lakme E373 CL
 Beckton Julian GG B571
 Bkt Suffeina A828 DM
BECKTON BELGA S198 JL
 Beckton Julian G3 P608
 Beckton Belga P431 HR
 Beckton Herald FJ J776
 Beckton Belga F772 VG

DAM		Calv.Ease	BW	WW	YW	Milk	HPG	Stay	Maint.En.
Age	3	12	-2.8	39	71	21	12	14	-0.2
Wt	940	Marb +.01		REA +.09		Bfat -.01			
Prog.BW	71	BWt	WWt	WR	ADG	YWt	YR	Scr.	Fr.
WR	116	74	698	122	3.69	1188	114	36	5.5
YR	111								
Wean Pct.	70%								
Cow Eff.	147								

★★★★★ for Low Maintenance, Growth, Superior Cow, High Cow Efficiency, Calving Ease, Stayability.

134 TR NEBULA WT976
1-A 100% # 1324419 Tattoo: TR2A9 WT97

Birth: 2-20-09
 Beckton Neptune R2 K065
BECKTON NEBULA M045
 Ref. Beckton Belga K285 JL
 Beckton Neptune RR B284
 Beckton Lana C735 TP
 Beckton Julian GG B571
 Beckton Belga G493 HR
 Bfck Cherokee Cnyn 4912
 Buf Crk Chf 824-1658
 MRM 1431 8611 9109
SGJ MISS RIGHT 178
 SGJ Sunny 119
 Farn Red Bang X55E
 Red Fancy 6252

DAM		Calv.Ease	BW	WW	YW	Milk	HPG	Stay	Maint.En.
Age	3	14	-4.7	25	47	11	12	12	-3.1
Wt	NA	Marb +.05		REA +.34		Bfat +.01			
Prog.BW	NA	BWt	WWt	WR	ADG	YWt	YR	Scr.	Fr.
WR	NA	65	600	101	3.06	1089	97	NA	5.5
YR	NA								
Wean Pct.	NA%								
Cow Eff.	NA								

★★★★★ for Low Maintenance, Rib-eye area, Calving Ease.

136 BECKTON WARRIOR W411 C4
1-A 100% # 1332196 Tattoo: BKT9 W411

Birth: 3-24-09
 Beckton Warrior CL M686
BECKTON WARRIOR C1 S337
 Ref. W-2 Beckton Christy K101 CD
 Beckton Warrior C C355
 Beckton Christy J223 LN
 Beckton Cody V E023
 Beckton Christy C306 JL
 Bkt Clifftop TV G672
 Beckton Lana J384 CD
BECKTON ROSE R507 CT
 Beckton Clifftop T3 N800
 Beckton Rose N125 LN
 Beckton Lancer T5 L095
 Beckton Rose L311 LN

DAM		Calv.Ease	BW	WW	YW	Milk	HPG	Stay	Maint.En.
Age	4	11	-1.6	31	62	15	10	12	4.9
Wt	1150	Marb +.12		REA +.19		Bfat -.01			
Prog.BW	72	BWt	WWt	WR	ADG	YWt	YR	Scr.	Fr.
WR	103	82	597	103	3.87	1094	102	35	5.0
YR	101								
Wean Pct.	50%								
Cow Eff.	106								

★★★★★ for Marbling, Rib-eye area, Calving Ease.



137 BECKTON CLIFFTOP W234 C3
1-A 100% # 1332110 Tattoo: BKT9 W234

Birth: 3-15-09
 Beckton Clifftop T C075
BKT CLIFFTOP TP R288
 Ref. B-1 Beckton Christy K209 CO
 Beckton BJR Topper 5241
 Beckton Barmaid A761 TR
 Beckton Copper JT G095
 Beckton Christy A111 VQ
 Beckton Colt G552
 Beckton Angel H164 LO
BECKTON LARKABA P061 CK
 Beckton Colt K M609
 Beckton Larkaba M728 EP
 Beckton Epic K1 K863
 Beckton Larkaba K139 EP

DAM		Calv.Ease	BW	WW	YW	Milk	HPG	Stay	Maint.En.
Age	5	15	-6.6	20	46	18	8	13	-4.1
Wt	885	Marb +.03		REA +.25		Bfat +.00			
Prog.BW	62	BWt	WWt	WR	ADG	YWt	YR	Scr.	Fr.
WR	101	64	597	103	3.96	1103	103	36	4.5
YR	99								
Wean Pct.	68%								
Cow Eff.	142								

★★★★★ for Low Maintenance, Rib-eye area, High Cow Efficiency, Calving Ease, Stayability.

• Bulls •

138 BECKTON JULIO W184 H2
1-A 100% # 1332306 Tattoo: BKT9 W184

Birth: 3-12-09
 Beckton Julian G1 J526 < Beckton Julian GG B571
 Beckton Annie F743 LN
BECKTON JULIO L233
 Ref. J < Beckton Rose J725 EP < Beckton Epic K F075
 Beckton Rose F192 CL
 Beckton Hustler C2 L079
BECKTON LARKABA S838 HS
 Beckton Hasten P292 < Beckton Sheba L644 CH
 Beckton Warrior C C355
 Beckton Larkaba M715 WR < Beckton Larkaba D388 SC

DAM		Calv.Ease	BW	WW	YW	Milk	HPG	Stay	Maint.En.
Age	3	13	-3.9	24	57	15	7	15	-5.8
Wt	935	Marb +0.07		REA +0.07		Bfat +0.01			
Prog.BW	65	BWt	WWt	WR	ADG	YWt	YR	Scr.	Fr.
WR	110	70	581	106	3.92	1087	104	35	5.0
YR	105								
Wean Pct.	58%								
Cow Eff.	122								

★★★★★ for Low Maintenance, Superior Cow, High Cow Efficiency, Calving Ease, Stayability.

141 BECKTON NEBULA W377 L3
1-A 100% # 1331721 Tattoo: BSF9 W377

Birth: 3-22-09
 Beckton Nebula M045 < Beckton Neptune R2 K065
 Beckton Belga K285 JL
BECKTON NEBULA H R233
 Ref. N-4 < Beckton Coca H132 HD < Beckton Hadrian F C486
 Beckton Coca CB74 JV
 Beckton Lancer 9380
BECKTON CHRISTY N626 LN
 Beckton Lancer T A664 < Beckton Coca 9119 TJ
 Beckton Copper JT G095
 Beckton Christy K209 CO < Beckton Christy A111 VQ

DAM		Calv.Ease	BW	WW	YW	Milk	HPG	Stay	Maint.En.
Age	6	15	-4.3	23	50	13	11	13	-2.7
Wt	1180	Marb +0.08		REA +0.17		Bfat +0.00			
Prog.BW	60	BWt	WWt	WR	ADG	YWt	YR	Scr.	Fr.
WR	106	72	620	104	3.33	1084	102	39	5.0
YR	102								
Wean Pct.	53%								
Cow Eff.	111								

★★★★★ for Low Maintenance, Rib-eye area, Calving Ease, Stayability.

139 BECKTON WARRIOR W026 E6
1-A 100% # 1332388 Tattoo: BKT9 W026

Birth: 2-22-09
 Beckton Warrior N645 T1 < Beckton Warrior T1 H281
 Beckton Rose H074 EP
BECKTON WARRIOR T248 L5
 Ref. W-3 < Beckton Lancer F442 T
 Beckton Kit F468 JL
 Beckton Epic KJ J722
BECKTON COCA T336 EP
 Beckton Epic K3 M606 < Beckton Lana F268 CT
 Beckton Neptune R2 K065
 Beckton Coca N459 NP < Beckton Coca HA28 WR

DAM		Calv.Ease	BW	WW	YW	Milk	HPG	Stay	Maint.En.
Age	2	13	-4.4	19	47	10	8	13	-5.6
Wt	765	Marb +0.04		REA +0.18		Bfat -0.01			
Prog.BW	54	BWt	WWt	WR	ADG	YWt	YR	Scr.	Fr.
WR	100	54	522	100	3.83	1062	106	37	5.0
YR	106								
Wean Pct.	60%								
Cow Eff.	127								

★★★★★ for Low Maintenance, Rib-eye area, High Cow Efficiency, Calving Ease, Stayability.



140 BECKTON NEBULA W210 L3
1-A 100% # 1331712 Tattoo: BSF9 W210

Birth: 3-14-09
 Beckton Nebula M045 < Beckton Neptune R2 K065
 Beckton Belga K285 JL
BECKTON NEBULA J R475
 Ref. N-5 < Beckton Larkeisa M138 JC < Beckton Justice G302
 Bkt Larkeisa G448 CT
 Beckton Lancer T A664
BECKTON ROSE N375 LN
 Beckton Lancer TH K417 < Beckton Angel G356 HR
 Beckton Cobalt K Z100
 Beckton Rose D731 CB < Beckton Rose Z060 RD

DAM		Calv.Ease	BW	WW	YW	Milk	HPG	Stay	Maint.En.
Age	6	14	-3.4	26	58	13	11	13	-4.7
Wt	1210	Marb +0.08		REA +0.09		Bfat -0.01			
Prog.BW	63	BWt	WWt	WR	ADG	YWt	YR	Scr.	Fr.
WR	105	70	585	101	3.29	1027	96	35	5.0
YR	104								
Wean Pct.	48%								
Cow Eff.	102								

★★★★★ for Low Maintenance, Superior Cow, Calving Ease, Stayability.

142 BECKTON JUSTICE W454 E6
1-A 100% # 1331736 Tattoo: BSF9 W454

Birth: 3-26-09
 Beckton Justice C1 R483 < Beckton Justice CH M056
 Beckton Tamara J124 HR
BECKTON JUSTICE T124 C1
 Ref. J-7 < Beckton Scarlett R808 NB < Beckton Nebula M045
 Andras Scarlett 2029
 Beckton Epic K F075
BECKTON BELGA P119 EP
 Beckton Epic KJ J722 < Beckton Lana F891 JL
 Beckton Julian 7526G
 Beckton Belga K476 JL < Beckton Belga F772 VG

DAM		Calv.Ease	BW	WW	YW	Milk	HPG	Stay	Maint.En.
Age	5	12	-2.6	31	63	16	10	14	-3.8
Wt	1105	Marb +0.13		REA +0.02		Bfat +0.01			
Prog.BW	72	BWt	WWt	WR	ADG	YWt	YR	Scr.	Fr.
WR	98	78	664	112	3.78	1108	104	38	5.0
YR	101								
Wean Pct.	60%								
Cow Eff.	127								

★★★★★ for Low Maintenance, Marbling, High Cow Efficiency, Calving Ease, Stayability.

• Bulls •

143 BECKTON WARRIOR W390 W4

1-A 100% # 1331771 Tattoo: BSF9 W390

Birth: 3-23-09

Beckton Warrior CL M686
 Beckton Warrior C C355
 Beckton Christy J223 LN

BECKTON WARRIOR C1 S337
 Ref. W-2
 Beckton Christy K101 CD
 Beckton Cody V E023
 Beckton Christy C306 JL
 Beckton Warrior T1 H281
 Beckton Warrior TC E801
 Beckton Minerva B609 RN

BECKTON MONA P874 WR
 Beckton Mona L724 CO
 Beckton Copper JG H648
 Beckton Mona F674 NP

DAM		Calv.Ease	BW	WW	YW	Milk	HPG	Stay	Maint.En.
Age	5	13	-3.6	27	56	12	13	10	-1.6
Wt	1025	Marb		-0.03	REA		+0.07	Bfat	
Prog.BW	60							-.01	
WR	96	BWt	WWt	WR	ADG	YWt	YR	Scr.	Fr.
YR	95	70	575	97	3.51	1043	98	36	4.5
Wean Pct.	56%								
Cow Eff.	118								

★★★★★ for Low Maintenance, High Cow Efficiency, Calving Ease.

146 BECKTON LOKI W329 D4

1-A 100% # 1331821 Tattoo: BSF9 W329

Birth: 3-20-09

Beckton Loki C M740
 Beckton Loki F251
 BKT Larkeisa J051 CK

BECKTON LOKI CL S284
 Ref. L-2
 Beckton Lakme J460 LT
 Beckton Latigo G714
 Beckton Lakme G128 HD
 Beckton Dominor ZC M919
 Beckton Dominor Z E401
 Beckton Barmaid J012 CO

BKT LARKEISA R676 DM
 BKT Larkeisa M816 EP
 Beckton Epic KJ J722
 BKT Larkeisa J076 DM

DAM		Calv.Ease	BW	WW	YW	Milk	HPG	Stay	Maint.En.
Age	4	14	-5.7	21	44	18	9	15	-4.5
Wt	NA	Marb		+0.18	REA		-0.04	Bfat	
Prog.BW	66							+0.01	
WR	102	BWt	WWt	WR	ADG	YWt	YR	Scr.	Fr.
YR	102	61	586	99	4.01	1006	95	36	5.0
Wean Pct.	NA%								
Cow Eff.	NA								

★★★★★ for Low Maintenance, Gainability, Marbling, Calving Ease, Stayability.

144 BECKTON HASTEN W608 L3

1-A 100% # 1331680 Tattoo: BSF9 W608

Birth: 4-4-09

Beckton Hasten P292
 Beckton Hustler C2 L079
 Beckton Sheba L644 CH

BECKTON HASTEN H S462
 Ref. H-2
 Beckton Lakme G128 HD
 Beckton Hadrian FC E166
 Beckton Lakme E373 CL
 Beckton Loki F251
 Beckton Lancer TZ D525
 Bkt Pine Marie D126 JL

BECKTON MINERVA M369 LO
 Beckton Minerva H403 LN
 Beckton Lancer TZ D525
 Beckton Minerva D648 JL

DAM		Calv.Ease	BW	WW	YW	Milk	HPG	Stay	Maint.En.
Age	7	13	-3.0	33	58	17	6	14	-2.5
Wt	1060	Marb		+0.07	REA		+0.04	Bfat	
Prog.BW	65							+0.00	
WR	101	BWt	WWt	WR	ADG	YWt	YR	Scr.	Fr.
YR	96	79	638	107	3.15	1072	100	36	5.0
Wean Pct.	60%								
Cow Eff.	127								

★★★★★ for Low Maintenance, High Cow Efficiency, Calving Ease, Stayability.

147 BECKTON NEBULA W219 J4

1-A 100% # 1332075 Tattoo: BKT9 W219

Birth: 3-15-09

Beckton Nebula E P084
 Beckton Nebula M045
 BKT Pine Marie M119 EP

BECKTON NEBULA EN S347
 Ref. N-7
 Beckton Eola P530 NB
 Beckton Nebula M045
 Beckton Eola M663 EP
 Beckton Justice G302
 Beckton Julian GG B571
 Bkt Vernice 9733 PC

BECKTON MAIATA M854 JC
 Beckton Maiata C997 CB
 Beckton Cobalt K Z100
 BchRchLilo 333K35L444

DAM		Calv.Ease	BW	WW	YW	Milk	HPG	Stay	Maint.En.
Age	7	18	-7.1	17	33	10	13	16	-7.3
Wt	1095	Marb		+0.14	REA		+0.00	Bfat	
Prog.BW	71							+0.01	
WR	99	BWt	WWt	WR	ADG	YWt	YR	Scr.	Fr.
YR	99	58	544	92	3.60	975	92	38	5.0
Wean Pct.	50%								
Cow Eff.	105								

★★★★★ for Low Maintenance, Marbling, Calving Ease, Stayability.

145 BECKTON JUSTICE W672 C5

1-A 100% # 1331618 Tattoo: BSF9 W672

Birth: 4-10-09

Beckton Justice CH M056
 Beckton Justice C K449
 Beckton Ruth K802 HD

BECKTON JUSTICE C1 R483
 Ref. J-4
 Beckton Tamara J124 HR
 Beckton Herald F FA20
 Beckton Tamara F183 CT
 Beckton Champ RH F275
 Beckton Champ R A583
 Beckton Minola B156 HV

BECKTON COCA H051 CH
 Beckton Coca F048 LN
 Beckton Lancer TS D390
 Beckton Coca D042 DM

DAM		Calv.Ease	BW	WW	YW	Milk	HPG	Stay	Maint.En.
Age	11	12	-2.7	29	58	17	8	13	-5.4
Wt	1110	Marb		+0.08	REA		+0.01	Bfat	
Prog.BW	74							-.02	
WR	100	BWt	WWt	WR	ADG	YWt	YR	Scr.	Fr.
YR	98	74	635	107	3.96	1113	104	34	5.0
Wean Pct.	55%								
Cow Eff.	117								

★★★★★ for Low Maintenance, High Cow Efficiency, Calving Ease, Stayability.

148 BECKTON NEBULA W070 E4

1-A 100% # 1332361 Tattoo: BKT9 W070

Birth: 3-1-09

Beckton Nebula L P093
 Beckton Nebula M045
 Beckton Marta M021 LN

BECKTON NEBULA T398 V3
 Ref. N-11
 Beckton Minerva J615 VG
 Beckton Vegas PK F485
 Beckton Minerva F433 VG
 Beckton Epic K3 M606
 Beckton Epic KJ J722
 Beckton Lana F268 CT

BECKTON MINERVA T219 EP
 Beckton Minerva N728 HR
 Beckton Herald FJ J776
 Beckton Minerva J615 VG

DAM		Calv.Ease	BW	WW	YW	Milk	HPG	Stay	Maint.En.
Age	2	10	-1.2	36	64	13	9	13	-1.7
Wt	800	Marb		+0.04	REA		-0.01	Bfat	
Prog.BW	66							-.01	
WR	110	BWt	WWt	WR	ADG	YWt	YR	Scr.	Fr.
YR	106	66	589	110	3.74	1050	106	39	5.5
Wean Pct.	66%								
Cow Eff.	139								

★★★★★ for Low Maintenance, Growth, Superior Cow, High Cow Efficiency, Calving Ease, Stayability.

• Bulls •



151 BECKTON NEBULA W100 C3
1-A 100% # 1332386 Tattoo: BKT9 W100

Birth: 3-5-09
 Beckton Nebula M045
 Beckton Neptune R2 K065
 Beckton Belga K285 JL
BECKTON NEBULA T315 W2
 Ref. N Beckton Birdie P086 WR
 Beckton Warrior CL M686
 Beckton Birdie M877 LO
 Beckton Cherokee N N479
 BFCK Cherokee Cnyn 4912
 Beckton Dinah C440 NM
BECKTON RUTH T325 CQ
 Beckton Ruth H105 LO
 Beckton Loki F251
 Beckton Ruth F125 KA

DAM		Calv.Ease	BW	WW	YW	Milk	HPG	Stay	Maint.En.
Age	2	15	-5.4	26	53	16	9	16	-3.6
Wt	725								
Prog.BW	58								
WR	109								
YR	103								
Wean Pct.	70%								
Cow Eff.	148								
		Marb	+0.20		REA	+0.19		Bfat	+0.01
		BWt	58	WWt	568	WR	109	ADG	3.38
		YWt	1038	YR	103	Scr.	39	Fr.	5.0

★★★★★ for Low Maintenance, Marbling, Rib-eye area, Superior Cow, High Cow Efficiency, Calving Ease, Stayability.

149 BECKTON HASTEN W703 E3
1-A 100% # 1332207 Tattoo: BKT9 W703

Birth: 4-13-09
 Beckton Hasten P292
 Beckton Hustler C2 L079
 Beckton Sheba L644 CH
BECKTON HASTEN H S462
 Ref. H-2 Beckton Lakme G128 HD
 Beckton Hadrian FC E166
 Beckton Lakme E373 CL
 Beckton Epic KM M115
 Beckton Epic K F075
 Beckton Minerva F495 CH
BECKTON EMERA R709 EP
 Beckton Emera M259 EP
 Beckton Epic K F075
 Beckton Emera D880 CB

DAM		Calv.Ease	BW	WW	YW	Milk	HPG	Stay	Maint.En.
Age	4	11	-4.2	33	67	20	11	13	1.0
Wt	1045								
Prog.BW	68								
WR	107								
YR	108								
Wean Pct.	57%								
Cow Eff.	121								
		Marb	+0.03		REA	-0.03		Bfat	+0.01
		BWt	70	WWt	620	WR	107	ADG	4.01
		YWt	1158	YR	108	Scr.	38	Fr.	5.0

★★★★★ for Low Maintenance, Growth, Gainability, Superior Cow, High Cow Efficiency, Calving Ease, Stayability.

152 BECKTON NEBULA W347 J4
1-A 100% # 1332158 Tattoo: BKT9 W347

Birth: 3-21-09
 Beckton Nebula P P707
 Beckton Nebula M045
 Beckton Lana M809 EP
BECKTON NEBULA PJ S543
 Ref. N-8 Beckton Lana P685 JO
 Beckton Julio L233
 Beckton Lana E083 CD
 Beckton Justice G302
 Beckton Julian GG B571
 Bkt Vernice 9733 PC
BECKTON FIREFLY R146 JC
 Beckton Firefly H437 LN
 Beckton Lancer TS D390
 Beckton Firefly B018 KR

DAM		Calv.Ease	BW	WW	YW	Milk	HPG	Stay	Maint.En.
Age	4	15	-5.0	31	59	10	10	14	-2.6
Wt	1190								
Prog.BW	56								
WR	96								
YR	96								
Wean Pct.	43%								
Cow Eff.	90								
		Marb	+0.10		REA	+0.10		Bfat	+0.01
		BWt	50	WWt	529	WR	99	ADG	3.60
		YWt	1009	YR	98	Scr.	38	Fr.	5.0

★★★★★ for Low Maintenance, Calving Ease, Stayability.

150 BECKTON JULIO W094 J3
1-A 100% # 1332407 Tattoo: BKT9 W094

Birth: 3-4-09
 Beckton Julio L233
 Beckton Julian G1 J526
 Beckton Rose J725 EP
BECKTON JULIO T863 H2
 Ref. J-8 Beckton Vernice N598 HU
 Beckton Hustler CN J102
 Beckton Vernice C047 JL
 Beckton Julio L233
 Beckton Julian G1 J526
 Beckton Rose J725 EP
BECKTON CHRISTY T410 JO
 Beckton Christy K101 CD
 Beckton Cody V E023
 Beckton Christy C306 JL

DAM		Calv.Ease	BW	WW	YW	Milk	HPG	Stay	Maint.En.
Age	2	12	-3.0	28	57	16	9	13	-5.9
Wt	830								
Prog.BW	64								
WR	105								
YR	102								
Wean Pct.	60%								
Cow Eff.	127								
		Marb	+0.06		REA	+0.05		Bfat	+0.00
		BWt	64	WWt	559	WR	105	ADG	3.56
		YWt	1009	YR	102	Scr.	39	Fr.	5.0

★★★★★ for Low Maintenance, High Cow Efficiency, Calving Ease, Stayability.

153 BECKTON JUSTICE W728 J5
1-A 100% # 1332045 Tattoo: BKT9 W728

Birth: 4-16-09
 Beckton Justice CH M056
 Beckton Justice C K449
 Beckton Ruth K802 HD
BECKTON JUSTICE C1 R483
 Ref. J-4 Beckton Tamara J124 HR
 Beckton Herald F FA20
 Beckton Tamara F183 CT
 Beckton Julian GG B571
 Beckton Julian 7526G
 Bkt Marta 9A13 JL
BECKTON ANNIE L680 JL
 Beckton Annie H113 LN
 Beckton Lancer TE F363
 Beckton Annie F743 LN

DAM		Calv.Ease	BW	WW	YW	Milk	HPG	Stay	Maint.En.
Age	8	18	-4.8	29	62	13	11	14	-3.0
Wt	1090								
Prog.BW	63								
WR	97								
YR	99								
Wean Pct.	55%								
Cow Eff.	115								
		Marb	+0.08		REA	+0.15		Bfat	+0.00
		BWt	69	WWt	598	WR	101	ADG	4.41
		YWt	1065	YR	100	Scr.	38	Fr.	5.0

★★★★★ for Low Maintenance, Gainability, Rib-eye area, Calving Ease, Stayability.

• Bulls •

154 BECKTON NEBULA W120 J4

1-A 100% # 1332331 Tattoo: BKT9 W120

Birth: 3-7-09

Beckton Nebula J R475
Beckton Nebula M045
Beckton Larkeisa M138 JC

BECKTON NEBULA T054 H3
Ref. N-9
BKT Pine Marie R401 HU
Beckton Hustler C2 L079
Bkt Pine Marie LC30 CD

Beckton Justice CE R599
Beckton Justice C K449
Beckton Belga M050 EP

BECKTON FIREFLY T106 JC
Beckton Firefly R146 JC
Beckton Justice G302
Beckton Firefly H437 LN

DAM		Calv.Ease	BW	WW	YW	Milk	HPG	Stay	Maint.En.
Age	2	14	-3.8	28	59	10	11	14	-5.4
Wt	825	Marb +.07		REA +.20		Bfat -.01			
Prog.BW	58	BWt	WWt	WR	ADG	YWt	YR	Scr.	Fr.
WR	100	58	523	100	3.38	997	99	35	5.0
YR	99								
Wean Pct.	56%								
Cow Eff.	118								

★★★★★ for Low Maintenance, Rib-eye area, High Cow Efficiency, Calving Ease, Stayability.

156 BECKTON CLIFFTOP W500 W3

1-A 100% # 1332258 Tattoo: BKT9 W500

Birth: 3-28-09

Beckton Clifftop T C075
BJR Topper 5241
Beckton Barmaid A761 TR

BKT CLIFFTOP TP R288
Ref. B-1
Beckton Christy K209 CO
Beckton Copper JT G095
Beckton Christy A111 VQ

Beckton Warrior CL M686
Beckton Warrior C C355
Beckton Christy J223 LN

BECKTON VERNICE S380 WR
Beckton Vernice K798 CD
Beckton Cody V E023
Beckton Vernice C047 JL

DAM		Calv.Ease	BW	WW	YW	Milk	HPG	Stay	Maint.En.
Age	3	11	-2.4	26	55	14	11	12	0.7
Wt	1090	Marb +.05		REA +.13		Bfat +.00			
Prog.BW	64	BWt	WWt	WR	ADG	YWt	YR	Scr.	Fr.
WR	95	77	562	100	3.06	1017	99	41	5.0
YR	94								
Wean Pct.	48%								
Cow Eff.	101								

★★★★★ for Low Maintenance, Rib-eye area, Calving Ease.

155 BECKTON LANCER W085 J5

1-A 100% # 1332341 Tattoo: BKT9 W085

Birth: 3-3-09

Beckton Lancer F442 T
Beckton Lancer T A664
Bkt Suffeina A828 DM

BECKTON LANCER T371 H4
Ref. L-3
Beckton Coca F276 HV
Leachman Heavenly 8141
Beckton Coca B112 CB

Beckton Justice C1 R483
Beckton Justice CH M056
Beckton Tamara J124 HR

BECKTON ROSE T144 JC
Beckton Rose R091 JC
Beckton Justice Cc N265
Beckton Rose N087 HL

DAM		Calv.Ease	BW	WW	YW	Milk	HPG	Stay	Maint.En.
Age	2	14	-3.3	27	59	14	8	13	1.7
Wt	800	Marb +.03		REA +.04		Bfat -.02			
Prog.BW	56	BWt	WWt	WR	ADG	YWt	YR	Scr.	Fr.
WR	101	56	539	101	3.42	990	100	35	5.0
YR	100								
Wean Pct.	60%								
Cow Eff.	126								

★★★★★ for Low Maintenance, High Cow Efficiency, Calving Ease, Stayability.

157 BECKTON EPITOMY W766 L2

1-A 100% # 1332175 Tattoo: BKT9 W766

Birth: 4-19-09

Beckton Epic K4 N795
Beckton Epic KJ J722
Beckton Sierra J789 EP

BECKTON EPITOMY S250
Ref. E-3
Beckton Tara M635 JL
Beckton Julian GG B571
Beckton Tara J266 HR

Beckton Laser N602
Beckton Lancer F442 T
Beckton Minola E589 TO

BECKTON FIREFLY R298 LS
Beckton Firefly N457 CO
Beckton Copper JT G095
Beckton Firefly K180 CH

DAM		Calv.Ease	BW	WW	YW	Milk	HPG	Stay	Maint.En.
Age	4	10	-1.4	26	59	16	7	17	0.9
Wt	1085	Marb +.15		REA +.14		Bfat +.01			
Prog.BW	73	BWt	WWt	WR	ADG	YWt	YR	Scr.	Fr.
WR	105	81	638	107	4.01	1085	102	42	5.0
YR	109								
Wean Pct.	57%								
Cow Eff.	120								

★★★★★ for Low Maintenance, Gainability, Marbling, Rib-eye area, Superior Cow, High Cow Efficiency, Calving Ease, Stayability.



158 BECKTON JET W561 C2

1-A 100% # 1332148 Tattoo: BKT9 W561

Birth: 4-1-09

TR Julian LT151
Beckton Julian GG B571
MS Geometric 917

BECKTON JET L P491
Ref. J-2
Beckton Minerva L278 LN
Beckton Lancer TS D390
Beckton Minerva F495 CH

Beckton Cherokee N N479
BFCK Cherokee Cnyn 4912
Beckton Dinah C440 NM

BECKTON SUSAN R022 CQ
Beckton Susan N023 JE
Beckton Jules L429
Beckton Susan L258 LR

DAM		Calv.Ease	BW	WW	YW	Milk	HPG	Stay	Maint.En.
Age	4	16	-6.4	21	40	23	10	17	-1.4
Wt	955	Marb +.14		REA +.14		Bfat +.01			
Prog.BW	63	BWt	WWt	WR	ADG	YWt	YR	Scr.	Fr.
WR	109	66	602	101	3.02	1018	96	37	5.0
YR	105								
Wean Pct.	61%								
Cow Eff.	128								

★★★★★ for Low Maintenance, Marbling, Rib-eye area, Superior Cow, High Cow Efficiency, Calving Ease, Stayability.

• Bulls •

159 BECKTON NEBULA W190 J3

1-A 100% # 1332305 Tattoo: BKT9 W190

Birth: 3-13-09
 Beckton Nebula M045
 Beckton Neptune R2 K065
 Beckton Belga K285 JL
BECKTON NEBULA H R233
 Ref. N-4 Beckton Coca H132 HD
 Beckton Hadrian F C486
 Beckton Coca CB74 JV
 Beckton Julian G1 J526
 Beckton Julian GG B571
BECKTON LANA S831 JL
 Beckton Lana N041 LN
 Beckton Lancer T5 L095
 Beckton Lana L923 CD

DAM		Calv.Ease	BW	WW	YW	Milk	HPG	Stay	Maint.En.
Age	3	15	-3.8	29	57	10	10	14	-3.0
Wt	940								
Prog.BW	64								
WR	96								
YR	96								
Wean Pct.	54%								
Cow Eff.	113								
		Marb	-0.04		REA	+0.15		Bfat +0.00	
		BWt	WWt	WR	ADG	YWt	YR	Scr.	Fr.
		54	546	99	3.87	1056	101	35	5.0

★★★★★ for Low Maintenance, Rib-eye area, Calving Ease, Stayability.

162 BECKTON HERITAGE W437 J3

1-A 100% # 1332484 Tattoo: BKT9 W437

Birth: 3-25-09
 Beckton Heritage N013
 Beckton Hustler C2 L079
 Beckton Lana L007 JL
BECKTON HERITAGE T270 J2
 Ref. H-3 Beckton Coca P602 JL
 Beckton Julian GG B571
 Beckton Coca J270 CD
 Beckton Julian G1 J526
 Beckton Serena L042 CR
BECKTON ROSE T776 JR
 Beckton Jupiter R478
 Beckton Rose R152 LS
 Beckton Laser N602
 Beckton Rose N607 CO

DAM		Calv.Ease	BW	WW	YW	Milk	HPG	Stay	Maint.En.
Age	2	11	-1.3	39	72	15	8	18	2.4
Wt	885								
Prog.BW	69								
WR	107								
YR	106								
Wean Pct.	56%								
Cow Eff.	118								
		Marb	+0.17		REA	+0.13		Bfat +0.00	
		BWt	WWt	WR	ADG	YWt	YR	Scr.	Fr.
		69	558	107	3.78	1063	106	31	5.0

★★★★★ for Low Maintenance, Growth, Marbling, Rib-eye area, Superior Cow, High Cow Efficiency, Calving Ease, Stayability.

160 BECKTON HASTEN W722

1-A 100% # 1332150 Tattoo: BKT9 W722

Birth: 4-15-09
 Beckton Hasten P292
 Beckton Hustler C2 L079
 Beckton Sheba L644 CH
BECKTON HASTEN H S462
 Ref. H-2 Beckton Lakme G128 HD
 Beckton Hadrian FC E166
 Beckton Lakme E373 CL
 TR Romeo NT379
 Buffalo Creek Romeo L081
BECKTON MINERVA R026 RA
 Beckton Minerva N250 CE
 Beckton Cruiser K118
 Beckton Minerva G034 BR

DAM		Calv.Ease	BW	WW	YW	Milk	HPG	Stay	Maint.En.
Age	4	15	-4.7	25	50	18	10	12	-0.3
Wt	975								
Prog.BW	57								
WR	104								
YR	103								
Wean Pct.	60%								
Cow Eff.	126								
		Marb	-0.01		REA	+0.07		Bfat -0.01	
		BWt	WWt	WR	ADG	YWt	YR	Scr.	Fr.
		62	602	101	3.38	1029	97	34	5.0

★★★★★ for Low Maintenance, High Cow Efficiency, Calving Ease.



161 BECKTON NEBULA W713 C4

1-A 100% # 1332094 Tattoo: BKT9 W713

Birth: 4-14-09
 Beckton Nebula E P084
 Beckton Nebula M045
 BKT Pine Marie M119 EP
BECKTON NEBULA EN S347
 Ref. N-7 Beckton Eola P530 NB
 Beckton Nebula M045
 Beckton Eola M663 EP
 Beckton Copper JT G095
 Beckton Copper J E616
BECKTON FIREFLY N457 CO
 Beckton Firefly K180 CH
 Beckton Ruth E549 TP
 Beckton Champ R1 H024
 Beckton Firefly H314 EP

DAM		Calv.Ease	BW	WW	YW	Milk	HPG	Stay	Maint.En.
Age	6	15	-6.3	21	45	18	11	17	-4.8
Wt	1100								
Prog.BW	66								
WR	102								
YR	100								
Wean Pct.	56%								
Cow Eff.	119								
		Marb	+0.32		REA	+0.01		Bfat +0.01	
		BWt	WWt	WR	ADG	YWt	YR	Scr.	Fr.
		65	621	104	3.42	1058	100	37	5.0

★★★★★ for Low Maintenance, Marbling, High Cow Efficiency, Calving Ease, Stayability.

163 BECKTON NOMAD W638 E2

1-A 100% # 1331637 Tattoo: BSF9 W638

Birth: 4-6-09
 Beckton Neva 5562
 Beckton Pine 2778-8
 Bkt Mona 1634-1549
BECKTON NOMAD 7496
 Ref. V Bkt Bolt Tamrck 3913
 Thunderbolt
 MD 373 RC 523
 Beckton Epic K F075
 Beckton Epic D404
BECKTON MONA J715 EP
 Beckton Mona D086 JL
 Beckton Belga D483 KR
 Beckton Julian GV Z693
 Beckton Mona 9356 KR

DAM		Calv.Ease	BW	WW	YW	Milk	HPG	Stay	Maint.En.
Age	10	12	-4.9	20	32	9	10	11	-5.2
Wt	1170								
Prog.BW	73								
WR	102								
YR	103								
Wean Pct.	47%								
Cow Eff.	98								
		Marb	+0.04		REA	-0.27		Bfat +0.02	
		BWt	WWt	WR	ADG	YWt	YR	Scr.	Fr.
		70	545	94	3.60	985	92	36	5.0

★★★★★ for Low Maintenance, Calving Ease.

• Bulls •

164 BECKTON NEBULA W398 N2
1-A 100% # 1331984 Tattoo: BSF9 W398

Birth: 3-23-09
 ↗ Beckton Neptune R2 K065 ↘ Beckton Neptune RR B284
 ↗ Beckton Lana C735 TP ↘
BECKTON NEBULA M045
 Ref. N-1 ↘ Beckton Belga K285 JL ↘ Beckton Julian GG B571
 ↘ Beckton Belga G493 HR ↘
 ↗ Beckton Nexus L016 ↘ Beckton Neptune R1 J245
BECKTON COCA T844 NX
 ↗ Beckton Coca M175 LN ↘ Beckton Coca J276 CL
 ↘ Beckton Lancer F442 T ↘ Beckton Coca K295 CO

DAM		Calv.Ease	BW	WW	YW	Milk	HPG	Stay	Maint.En.
Age	2	14	-4.0	30	69	11	13	12	-0.9
Wt	925								
Prog.BW	66								
WR	101								
YR	104								
Wean Pct.	51%								
Cow Eff.	107								
		BWt	WWt	WR	ADG	YWt	YR	Scr.	Fr.
		66	529	101	4.05	1039	104	39	5.5

★★★★★ for Low Maintenance, Gainability, Calving Ease.

167 BECKTON NEBULA W746 J3
1-A 100% # 1331911 Tattoo: BSF9 W746

Birth: 4-18-09
 ↗ Beckton Nebula M045 ↘ Beckton Neptune R2 K065
 ↗ Beckton Belga K285 JL ↘
BECKTON NEBULA L P093
 Ref. N-2 ↘ Beckton Marta M021 LN ↘ Beckton Lancer TA K644
 ↘ Beckton Marta K254 LN ↘
 ↗ Beckton Julio L233 ↘ Beckton Julian G1 J526
BECKTON RUTH S671 JO
 ↗ Beckton Ruth F125 KA ↘ Beckton Rose J725 EP
 ↘ Beckton Kannon D202 ↘ Beckton Ruth D247 KR

DAM		Calv.Ease	BW	WW	YW	Milk	HPG	Stay	Maint.En.
Age	3	12	-2.7	30	57	6	9	14	-6.4
Wt	765								
Prog.BW	65								
WR	96								
YR	96								
Wean Pct.	70%								
Cow Eff.	148								
		BWt	WWt	WR	ADG	YWt	YR	Scr.	Fr.
		69	577	103	3.74	1065	103	33	5.5

★★★★★ for Low Maintenance, Rib-eye area, High Cow Efficiency, Calving Ease, Stayability.

165 BECKTON LANCER W115 L5
1-A 100% # 1332408 Tattoo: BKT9 W115

Birth: 3-6-09
 ↗ Beckton Lancer F442 T ↘ Beckton Lancer T A664
 ↗ Bkt Suffeina A828 DM ↘
BECKTON LANCER T371 H4
 Ref. L-3 ↘ Beckton Coca F276 HV ↘ Leachman Heavenly 8141
 ↘ Beckton Coca B112 CB ↘
 ↗ Beckton Lancer T9 N586 ↘ Beckton Lancer TA K644
BECKTON LANA T411 LN
 ↗ Beckton Lana N388 LO ↘ BKT Larkeisa H232 SC
 ↘ Beckton Loki F251 ↘ Beckton Lana E083 CD

DAM		Calv.Ease	BW	WW	YW	Milk	HPG	Stay	Maint.En.
Age	2	14	-4.0	24	52	13	6	13	-1.2
Wt	835								
Prog.BW	50								
WR	97								
YR	99								
Wean Pct.	53%								
Cow Eff.	112								
		BWt	WWt	WR	ADG	YWt	YR	Scr.	Fr.
		50	504	97	3.33	989	99	36	5.0

★★★★★ for Low Maintenance, Rib-eye area, Calving Ease, Stayability.

168 BECKTON WARRIOR W758 L4
1-A 100% # 1331614 Tattoo: BSF9 W758

Birth: 4-18-09
 ↗ Beckton Warrior CL M686 ↘ Beckton Warrior C C355
 ↗ Beckton Christy J223 LN ↘
BECKTON WARRIOR C1 S337
 Ref. W-2 ↘ Beckton Christy K101 CD ↘ Beckton Cody V E023
 ↘ Beckton Christy C306 JL ↘
 ↗ Beckton Lancer T A664 ↘ Beckton Lancer 9380
BECKTON MARTA G512 LN
 ↗ Beckton Marta C314 JL ↘ Beckton Coca 9119 TJ
 ↘ Beckton Julian 7526G ↘ Beckton Marta 8955KR

DAM		Calv.Ease	BW	WW	YW	Milk	HPG	Stay	Maint.En.
Age	12	18	-6.3	22	52	12	10	14	-1.8
Wt	1000								
Prog.BW	68								
WR	96								
YR	98								
Wean Pct.	55%								
Cow Eff.	117								
		BWt	WWt	WR	ADG	YWt	YR	Scr.	Fr.
		60	573	96	3.65	1053	99	36	5.0

★★★★★ for Low Maintenance, Rib-eye area, High Cow Efficiency, Calving Ease, Stayability.

166 BECKTON RANGER W367 J4
1-A 100% # 1332376 Tattoo: BKT9 W367

Birth: 3-22-09
 ↗ Beckton Ranger 9479R ↘ Beckton Ranger 7003
 ↗ Beckton Eola 7470 RZ ↘
BECKTON RANGER T603 H3
 Ref. R-1 ↘ Beckton Rose N044 HU ↘ Beckton Hustler C2 L079
 ↘ Beckton Rose L669 JL ↘
 ↗ Beckton Jupiter R478 ↘ Beckton Julian G1 J526
BECKTON TAMARA T292 JR
 ↗ Beckton Tamara R081 LS ↘ Beckton Serena L042 CR
 ↘ Beckton Laser N602 ↘ Beckton Tamara N095 LN

DAM		Calv.Ease	BW	WW	YW	Milk	HPG	Stay	Maint.En.
Age	2	12	-3.9	28	61	13	7	13	-2.2
Wt	825								
Prog.BW	57								
WR	102								
YR	110								
Wean Pct.	59%								
Cow Eff.	123								
		BWt	WWt	WR	ADG	YWt	YR	Scr.	Fr.
		57	543	102	4.32	1090	110	32	5.5

★★★★★ for Low Maintenance, Growth, Gainability, High Cow Efficiency, Calving Ease, Stayability.

169 BECKTON DOMINOR W614 W5
1-A 100% # 1332083 Tattoo: BKT9 W614

Birth: 4-5-09
 ↗ Beckton Dominor ZC M919 ↘ Beckton Dominor Z E401
 ↗ Beckton Barmaid J012 CO ↘
BECKTON DOMINOR Z1 R610
 Ref. D-1 ↘ Beckton Sierra K557 LO ↘ Beckton Loki F251
 ↘ Beckton Sierra C157 CL ↘
 ↗ Beckton Warrior TD L493 ↘ Beckton Warrior T C371
BECKTON LYDIA N081 WR
 ↗ Beckton Lydia L625 WR ↘ Bkt Suffeina A828 DM
 ↘ Beckton Warrior C C355 ↘ Beckton Lydia G059 WR

DAM		Calv.Ease	BW	WW	YW	Milk	HPG	Stay	Maint.En.
Age	6	16	-6.2	18	48	18	8	14	-0.4
Wt	1110								
Prog.BW	64								
WR	99								
YR	102								
Wean Pct.	46%								
Cow Eff.	96								
		BWt	WWt	WR	ADG	YWt	YR	Scr.	Fr.
		58	508	85	3.56	996	93	36	5.0

★★★★★ for Low Maintenance, Calving Ease, Stayability.

• Bulls •



172 BECKTON JULIAN W836 J5
1-A 100% # 1332249 Tattoo: BKT9 W836

Birth: 4-28-09
 Beckton Julian GJ P535
 Beckton Julian 7526G
 Beckton Mona D086 JL
BECKTON JULIAN G5 S107
 Ref. J-5 Beckton Minola P826 DM
 Beckton Dominor ZC M919
 Beckton Minola M641 WR
 Beckton Justice CH M056
 Beckton Justice C K449
BECKTON INDIGO S262 JC
 Beckton Indigo L588 LN
 Beckton Ruth K802 HD
 Beckton Lancer TL G626
 Bkt Indigo 9235 GL

DAM		Calv.Ease	BW	WW	YW	Milk	HPG	Stay	Maint.En.
Age	3	9	1.2	39	81	11	11	16	-0.6
Wt	985								
Prog.BW	68								
WR	101								
YR	99								
Wean Pct.	57%								
Cow Eff.	120								
		BWt	WWt	WR	ADG	YWt	YR	Scr.	Fr.
		81	603	107	3.51	1078	105	39	5.5

★★★★★ for Low Maintenance, Marbling, High Cow Efficiency, Calving Ease, Stayability.

170 BECKTON EMPEROR W356 C3
1-A 100% # 1332353 Tattoo: BKT9 W356

Birth: 3-22-09
 Beckton Emperor R100
 Beckton Epic K4 N795
 Beckton Tamara N180 JO
BECKTON EMPEROR T641 E2
 Ref. E-6 Beckton Vernice R416 EP
 Beckton Epic K3 M606
 Beckton Vernice K482 HD
 Beckton Clifftop T3 N800
 Bkt Clifftop TV G672
BECKTON SUSAN T199 CT
 Beckton Susan L258 LR
 Beckton Lana J384 CD
 MRM Lancer 916
 Beckton Susan F315 TP

DAM		Calv.Ease	BW	WW	YW	Milk	HPG	Stay	Maint.En.
Age	2	9	-1.8	26	54	16	6	13	-2.5
Wt	815								
Prog.BW	71								
WR	102								
YR	102								
Wean Pct.	60%								
Cow Eff.	125								
		BWt	WWt	WR	ADG	YWt	YR	Scr.	Fr.
		71	545	102	3.51	1004	102	36	5.5

★★★★★ for Low Maintenance, Marbling, High Cow Efficiency, Calving Ease, Stayability.

173 BECKTON NEBULA W527 L3
1-A 100% # 1332208 Tattoo: BKT9 W527

Birth: 3-30-09
 Beckton Nebula M045
 Beckton Neptune R2 K065
 Beckton Belga K285 JL
BECKTON NEBULA G S237
 Ref. N-6 Beckton Lakme LA06 JL
 Beckton Julian GG B571
 Beckton Lakme B370 HV
 Beckton Lancer T6 M467
 Beckton Lancer TL G626
BECKTON ROSE R711 LN
 Beckton Rose L311 LN
 Beckton Lana C735 TP
 Beckton Lancer F442 T
 Beckton Rose H292 HD

DAM		Calv.Ease	BW	WW	YW	Milk	HPG	Stay	Maint.En.
Age	4	18	-6.3	20	54	13	10	14	-4.3
Wt	1260								
Prog.BW	58								
WR	102								
YR	101								
Wean Pct.	40%								
Cow Eff.	85								
		BWt	WWt	WR	ADG	YWt	YR	Scr.	Fr.
		62	526	98	3.38	977	95	35	5.0

★★★★★ for Low Maintenance, Rib-eye area, Calving Ease, Stayability.

171 BECKTON HASTEN W759 J3
1-A 100% # 1331595 Tattoo: BSF9 W759

Birth: 4-19-09
 Beckton Hasten P292
 Beckton Hustler C2 L079
 Beckton Sheba L644 CH
BECKTON HASTEN H S462
 Ref. H-2 Beckton Lakme G128 HD
 Beckton Hadrian FC E166
 Beckton Lakme E373 CL
 Beckton Javelin RN Z358
 Bkt Javelin 7466 R
 Bkt Christy 8892 NM
BECKTON LARKABA D170 JV
 Beckton Larkaba Z257 ZN
 Beckton Zenith 9558L
 Bkt Larkaba 9596 SU

DAM		Calv.Ease	BW	WW	YW	Milk	HPG	Stay	Maint.En.
Age	15	12	-4.5	24	47	18	9	12	-2.3
Wt	1025								
Prog.BW	73								
WR	100								
YR	100								
Wean Pct.	56%								
Cow Eff.	118								
		BWt	WWt	WR	ADG	YWt	YR	Scr.	Fr.
		71	595	100	3.20	1044	98	36	5.0

★★★★★ for Low Maintenance, High Cow Efficiency, Calving Ease.

174 BECKTON EPIC W769 E4
1-A 100% # 1332218 Tattoo: BKT9 W769

Birth: 4-19-09
 Beckton Epic K F075
 Beckton Epic D404
 Beckton Belga D483 KR
BECKTON EPIC R350 K
 Ref. E-2 Beckton Larkaba E042 CD
 Beckton Cody C401
 Beckton Larkaba C317 CL
 Beckton Epic KJ J722
 Beckton Epic K F075
 Beckton Lana F891 JL
BECKTON TAMARA R816 EP
 Beckton Tamara K021 CH
 Beckton Champ R3 H338
 Beckton Tamara HA73 CH

DAM		Calv.Ease	BW	WW	YW	Milk	HPG	Stay	Maint.En.
Age	4	10	-2.2	23	49	16	7	11	-1.2
Wt	1055								
Prog.BW	63								
WR	101								
YR	98								
Wean Pct.	54%								
Cow Eff.	114								
		BWt	WWt	WR	ADG	YWt	YR	Scr.	Fr.
		75	590	99	3.29	1037	97	38	5.5

★★★★★ for Low Maintenance, Calving Ease.

• Bulls •

175 BECKTON NEBULA W734 E4
1-A 100% # 1332299 Tattoo: BKT9 W734

Birth: 4-17-09
 Beckton Nebula E P084
BECKTON NEBULA EN S347
 Ref. N-7
 Beckton Eola P530 NB
 Beckton Epic K3 M606
BECKTON BELGA S747 EP
 Beckton Belga K202 LN
 Beckton Nebula M045
 BKT Pine Marie M119 EP
 Beckton Nebula M045
 Beckton Eola M663 EP
 Beckton Epic KJ J722
 Beckton Lana F268 CT
 Beckton Lancer T A664
 Beckton Belga D460 KR

DAM		Calv.Ease	BW	WW	YW	Milk	HPG	Stay	Maint.En.
Age	3	16	-5.8	21	49	13	10	16	-5.5
Wt	925	Marb +0.22		REA +0.03		Bfat +0.01			
Prog.BW	63	BWt	WWt	WR	ADG	YWt	YR	Scr.	Fr.
WR	109	65	611	109	3.11	1055	102	36	5.5
YR	107								
Wean Pct.	62%								
Cow Eff.	130								

★★★★★ for Low Maintenance, Marbling, Superior Cow, High Cow Efficiency, Calving Ease, Stayability.

177 BECKTON ROMAN W801
1-A 100% # 1332056 Tattoo: BKT9 W801

Birth: 4-22-09
 TR Romeo NT379
BECKTON ROMAN J S158
 Ref. J-6
 Beckton Belga K285 JL
 Beckton Justice G302
BECKTON LARKEISA M138 JC
 Bkt Larkeisa G448 CT
 Buffalo Creek Romeo L081
 Buf Crk Lass L420
 Beckton Julian GG B571
 Beckton Belga G493 HR
 Beckton Julian GG B571
 Bkt Vernice 9733 PC
 Beckton Clifftop T C075
 Bkt Larkeisa C894 JV

DAM		Calv.Ease	BW	WW	YW	Milk	HPG	Stay	Maint.En.
Age	7	14	-2.6	29	54	12	11	15	-6.4
Wt	985	Marb +0.02		REA +0.35		Bfat +0.01			
Prog.BW	65	BWt	WWt	WR	ADG	YWt	YR	Scr.	Fr.
WR	97	66	552	93	3.60	1010	95	33	5.5
YR	101								
Wean Pct.	56%								
Cow Eff.	118								

★★★★★ for Low Maintenance, Rib-eye area, High Cow Efficiency, Calving Ease, Stayability.

176 BECKTON JULIAN W344 J5
1-A 100% # 1332317 Tattoo: BKT9 W344

Birth: 3-21-09
 Beckton Julian GG B571
BECKTON JULIAN T212 L4
 Ref. J
 Beckton Kit R517 LN
 Beckton Justice C2 R695
BECKTON ANNIE T016 JC
 Beckton Annie R650 DM
 Beckton Julian 7526G
 Bkt Marta 9A13 JL
 Beckton Lancer F442 T
 Beckton Kit F468 JL
 Beckton Justice CH M056
 Beckton Tamara M878 JC
 Beckton Dominor ZC M919
 Beckton Annie E066 WR

DAM		Calv.Ease	BW	WW	YW	Milk	HPG	Stay	Maint.En.
Age	2	18	-5.8	22	46	15	11	17	-7.7
Wt	735	Marb +0.13		REA +0.23		Bfat +0.00			
Prog.BW	51	BWt	WWt	WR	ADG	YWt	YR	Scr.	Fr.
WR	102	51	542	102	3.33	984	100	34	5.0
YR	100								
Wean Pct.	66%								
Cow Eff.	138								

★★★★★ for Low Maintenance, Marbling, Rib-eye area, High Cow Efficiency, Calving Ease, Stayability.

178 BECKTON NEBULA W802 J4
1-A 100% # 1332119 Tattoo: BKT9 W802

Birth: 4-22-09
 Beckton Nebula P P707
BECKTON NEBULA PJ S543
 Ref. N-8
 Beckton Lana P685 JO
 Beckton Julian G2 M345
BECKTON LANA P317 JL
 Beckton Lana M078 LN
 Beckton Nebula M045
 Beckton Lana M809 EP
 Beckton Julio L233
 Beckton Lana E083 CD
 Beckton Julian GG B571
 Beckton Lana H544 WR
 Beckton Lancer F442 T
 Beckton Lana G248 HR

DAM		Calv.Ease	BW	WW	YW	Milk	HPG	Stay	Maint.En.
Age	5	17	-5.5	22	56	11	9	15	-8.5
Wt	975	Marb +0.13		REA +0.19		Bfat +0.00			
Prog.BW	63	BWt	WWt	WR	ADG	YWt	YR	Scr.	Fr.
WR	98	62	502	84	3.51	980	92	34	5.5
YR	103								
Wean Pct.	52%								
Cow Eff.	109								

★★★★★ for Low Maintenance, Marbling, Rib-eye area, Calving Ease, Stayability.



179 BECKTON EPITOMY W694
1-A 100% # 1331598 Tattoo: BSF9 W694

Birth: 4-12-09
 Beckton Epic K4 N795
BECKTON EPITOMY S250
 Ref. E-3
 Beckton Tara M635 JL
 BUF CRK Hobo 1961
BKT LARKEISA E578 HB
 Bkt Larkeisa B312 CB
 Beckton Epic KJ J722
 Beckton Sierra J789 EP
 Beckton Julian GG B571
 Beckton Tara J266 HR
 BUF CRK Hobo 1413
 BUF CRK Carrie 1174
 Beckton Cobalt K Z100
 Bkt Larkeisa Z116 CB

DAM		Calv.Ease	BW	WW	YW	Milk	HPG	Stay	Maint.En.
Age	14	12	-2.5	21	48	14	9	13	-1.3
Wt	1055	Marb +0.06		REA -0.05		Bfat +0.01			
Prog.BW	76	BWt	WWt	WR	ADG	YWt	YR	Scr.	Fr.
WR	101	72	550	93	3.29	1003	94	NA	5.0
YR	103								
Wean Pct.	50%								
Cow Eff.	106								

★★★★★ for Low Maintenance, Calving Ease, Stayability.

• Bulls •

180 **TR JAX WT965**
1-A 100% # 1324439 Tattoo: TR2A9 WT96

Birth: 3-10-09
 ✓ Beckton Julian GG B571
 ✓ BKT Julian 7526 G
 ✓ BKT Marta 9A13 JL
TR JULIAN ST630
 Ref. ✓ Ms Geometric 003
 ✓ BJR Make My Day 981
 ✓ Ms Geometric 277
 ✓ Buf Crk Chf 824-1658
 ✓ MRM 1431 8611 9109
TR LASS NT315
 ✓ Bfck Cherokee Cnyn 4912
 ✓ Buf Crk Lass L011A
 ✓ Buf Crk Julesburg 5807
 ✓ Buf Crk Lass 5545

DAM		Calv.Ease	BW	WW	YW	Milk	HPG	Stay	Maint.En.
Age	6	11	-1.7	33	55	14	13	16	-1.8
Wt	NA	Marb +0.04			REA +0.40		Bfat +0.01		
Prog.BW	NA	BWt	WWt	WR	ADG	YWt	YR	Scr.	Fr.
WR	NA	82	642	108	3.22	1158	103	NA	5.5
YR	NA								
Wean Pct.NA%	NA								
Cow Eff.	NA								

★★★★★ for Low Maintenance, Rib-eye area, Calving Ease, Stayability.

183 **TR NUGGET WT987**
1-A 100% # 1324416 Tattoo: TR2A9 WT98

Birth: 1-14-09
 ✓ Beckton Nebula M045
 ✓ Beckton Neptune R2 K065
 ✓ Beckton Belga K285 JL
TR NEBULA TT779
 Ref. ✓ TR Lydia MT244
 ✓ Beckton Lancer F134 TS
 ✓ Beckton Lydia E251 CL
 ✓ TR Julian LT142
 ✓ Mushrush Lana 1061
TR MINOLA TT718
 ✓ Mushrush LT N020
 ✓ Buf Crk Minola L387
 ✓ Buf Crk Counterchf 5107
 ✓ Buf Crk Minola 5001

DAM		Calv.Ease	BW	WW	YW	Milk	HPG	Stay	Maint.En.
Age	2	15	-3.8	23	48	13	12	14	-2.8
Wt	NA	Marb +0.05			REA -0.01		Bfat +0.00		
Prog.BW	NA	BWt	WWt	WR	ADG	YWt	YR	Scr.	Fr.
WR	NA	62	514	90	3.38	1055	93	NA	4.0
YR	NA								
Wean Pct.NA%	NA								
Cow Eff.	NA								

★★★★★ for Low Maintenance, Calving Ease, Stayability.

181 **TR RICARDO WT957**
1-A 100% # 1324430 Tattoo: TR2A9 WT95

Birth: 3-9-09
 ✓ Bfck Cherokee Cnyn 4912
 ✓ Buf Crk Chf 824-1658
 ✓ MRM 1431 8611 9109
TR RICARDO RT574
 Ref. ✓ TR Dyna LT111
 ✓ Beckton Julian GG B571
 ✓ BSF Dyna JT976
 ✓ Beckton Lancer TS D390
 ✓ Beckton Tara D565 CB
TR LANA LT116
 ✓ Beckton Lancer F134 TS
 ✓ Beckton Lana E828 SC
 ✓ Beckton Scamp 8954
 ✓ Beckton Lana B695 SG

DAM		Calv.Ease	BW	WW	YW	Milk	HPG	Stay	Maint.En.
Age	8	13	-3.3	29	52	15	11	15	-3.2
Wt	NA	Marb +0.10			REA +0.27		Bfat +0.00		
Prog.BW	NA	BWt	WWt	WR	ADG	YWt	YR	Scr.	Fr.
WR	NA	78	624	105	3.25	1144	102	NA	5.0
YR	NA								
Wean Pct.NA%	NA								
Cow Eff.	NA								

★★★★★ for Low Maintenance, Rib-eye area, Calving Ease, Stayability.



182 **TR NEBULA WT953**
1-A 100% # 1324402 Tattoo: TR2A9 WT95

Birth: 2-17-09
 ✓ Beckton Neptune R2 K065
 ✓ Beckton Neptune RR B284
 ✓ Beckton Lana C735 TP
BECKTON NEBULA M045
 Ref. ✓ Beckton Belga K285 JL
 ✓ Beckton Julian GG B571
 ✓ Beckton Belga G493 HR
 ✓ Beckton Lancer T A664
 ✓ Beckton Lancer 9380
 ✓ Beckton Coca 9119 TJ
BUF CRK LASS 6356
 ✓ Buf Crk Lass 4773
 ✓ RCN Dynamo 732
 ✓ Buf Cr ET Lass VC889

DAM		Calv.Ease	BW	WW	YW	Milk	HPG	Stay	Maint.En.
Age	9	21	-8.2	14	37	6	9	13	-7.0
Wt	NA	Marb +0.11			REA +0.13		Bfat +0.00		
Prog.BW	NA	BWt	WWt	WR	ADG	YWt	YR	Scr.	Fr.
WR	NA	56	525	89	3.42	1072	95	NA	5.0
YR	NA								
Wean Pct.NA%	NA								
Cow Eff.	NA								

★★★★★ for Low Maintenance, Marbling, Rib-eye area, Calving Ease, Stayability.

184 **TR RICARDO WT967**
1-A 100% # 1324443 Tattoo: TR2A9 WT96

Birth: 3-13-09
 ✓ Bfck Cherokee Cnyn 4912
 ✓ Buf Crk Chf 824-1658
 ✓ MRM 1431 8611 9109
TR RICARDO RT574
 Ref. ✓ TR Dyna LT111
 ✓ Beckton Julian GG B571
 ✓ BSF Dyna JT976
 ✓ Beckton Lancer 9380
 ✓ Beckton Coca 9119 TJ
TR LANA NT331
 ✓ BSF Julian JT911
 ✓ TR Lana G760
 ✓ Beckton Julian G717 GG
 ✓ TR Lydia G750
 ✓ Beckton Cody V E023
 ✓ Beckton Lana E828 SC

DAM		Calv.Ease	BW	WW	YW	Milk	HPG	Stay	Maint.En.
Age	6	15	-3.9	30	52	14	12	14	-1.8
Wt	NA	Marb +0.12			REA +0.27		Bfat +0.00		
Prog.BW	NA	BWt	WWt	WR	ADG	YWt	YR	Scr.	Fr.
WR	NA	74	601	102	3.10	1097	97	NA	4.5
YR	NA								
Wean Pct.NA%	NA								
Cow Eff.	NA								

★★★★★ for Low Maintenance, Marbling, Rib-eye area, Calving Ease, Stayability.

• Bulls •

185 **BSF HERITAGE W071 J3**
1-B 99% # 1331940 Tattoo: BSF9 W071

Birth: 3-2-09
 Beckton Heritage N013
BECKTON HERITAGE T270 J2
 Ref. H-3
 Beckton Coca P602 JL
 Beckton Jupiter R478
BSF JULIANNE T092 JR
 BSF Julianne R779 JL
 Beckton Hustler C2 L079
 Beckton Lana L007 JL
 Beckton Julian GG B571
 Beckton Coca J270 CD
 Beckton Julian G1 J526
 Beckton Serena L042 CR
 Beckton Julian G1 J526
 BSF Regus K571 WR

DAM		Calv.Ease	BW	WW	YW	Milk	HPG	Stay	Maint.En.
Age	2	13	-2.8	38	65	13	8	16	-4.3
Wt	820	Marb +.09		REA +.07		Bfat +.00			
Prog.BW	63	BWt	WWt	WR	ADG	YWt	YR	Scr.	Fr.
WR	102	63	534	102	3.69	1033	103	38	5.0
YR	103								
Wean Pct.	58%								
Cow Eff.	122								

★★★★★ for Low Maintenance, High Cow Efficiency, Calving Ease, Stayability.

188 **BSF NEBULA W201 H3**
1-B 99% # 1331653 Tattoo: BSF9 W201

Birth: 3-14-09
 Beckton Nebula M045
BECKTON NEBULA J R475
 Ref. N-5
 Beckton Larkeisa M138 JC
 Beckton Herald F FA20
BSF REGUS L114 HR
 BSF Regus F114
 Beckton Neptune R2 K065
 Beckton Belga K285 JL
 Beckton Justice G302
 Bkt Larkeisa G448 CT
 Leachman Heavenly 8141
 Beckton Barona C548 FF
 Beckton Romulus D497
 BSF Regus D093

DAM		Calv.Ease	BW	WW	YW	Milk	HPG	Stay	Maint.En.
Age	8	16	-4.7	22	42	11	15	13	-6.0
Wt	1180	Marb +.07		REA +.13		Bfat +.00			
Prog.BW	69	BWt	WWt	WR	ADG	YWt	YR	Scr.	Fr.
WR	109	59	569	98	3.47	1012	94	36	4.5
YR	105								
Wean Pct.	48%								
Cow Eff.	102								

★★★★★ for Low Maintenance, Rib-eye area, Superior Cow, Calving Ease, Stayability.

186 **BSF NEBULA W299 L3**
1-B 99% # 1331769 Tattoo: BSF9 W299

Birth: 3-19-09
 Beckton Nebula M045
BECKTON NEBULA J R475
 Ref. N-5
 Beckton Larkeisa M138 JC
 Beckton Lancer T4 J536
BSF LANETTE P754
 BSF Regus L619 JL
 Beckton Neptune R2 K065
 Beckton Belga K285 JL
 Beckton Justice G302
 Bkt Larkeisa G448 CT
 Beckton Lancer TZ D525
 Beckton Vernice D121 VG
 Beckton Julian 7526G
 BSF Red E036

DAM		Calv.Ease	BW	WW	YW	Milk	HPG	Stay	Maint.En.
Age	5	17	-5.4	20	43	5	12	16	-8.9
Wt	1040	Marb +.06		REA +.17		Bfat +.00			
Prog.BW	60	BWt	WWt	WR	ADG	YWt	YR	Scr.	Fr.
WR	91	63	559	94	3.42	1027	96	36	4.5
YR	91								
Wean Pct.	54%								
Cow Eff.	113								

★★★★★ for Low Maintenance, Rib-eye area, Calving Ease, Stayability.

189 **BSF CLIFFTOP W601 J3**
1-B 99% # 1331880 Tattoo: BSF9 W601

Birth: 4-4-09
 Beckton Clifftop T C075
BKT CLIFFTOP TP R288
 Ref. B-1
 Beckton Christy K209 CO
 Beckton Justice CH M056
BSF LAUREL S358 JC
 BSF Laurel N838 LN
 BJR Topper 5241
 Beckton Barmaid A761 TR
 Beckton Copper JT G095
 Beckton Christy A111 VQ
 Beckton Justice C K449
 Beckton Ruth K802 HD
 Beckton Lancer TA K644
 BSF Regus H012

DAM		Calv.Ease	BW	WW	YW	Milk	HPG	Stay	Maint.En.
Age	3	12	-2.7	28	59	16	9	13	-5.0
Wt	NA	Marb +.15		REA +.26		Bfat -.01			
Prog.BW	68	BWt	WWt	WR	ADG	YWt	YR	Scr.	Fr.
WR	107	70	595	108	3.47	1068	103	34	5.0
YR	103								
Wean Pct.	NA%								
Cow Eff.	NA								

★★★★★ for Low Maintenance, Marbling, Rib-eye area, Calving Ease, Stayability.

187 **BSF EPITOMY W391 J2**
1-B 99% # 1331924 Tattoo: BSF9 W391

Birth: 3-23-09
 Beckton Epic K4 N795
BECKTON EPITOMY S250
 Ref. E-3
 Beckton Tara M635 JL
 Beckton Justice CH M056
BSF JUSTICIA S818 JC
 BSF Regus M902 CR
 Beckton Epic KJ J722
 Beckton Sierra J789 EP
 Beckton Julian GG B571
 Beckton Tara J266 HR
 Beckton Justice C K449
 Beckton Ruth K802 HD
 Beckton Colter HW J766
 BSF Red H467

DAM		Calv.Ease	BW	WW	YW	Milk	HPG	Stay	Maint.En.
Age	3	16	-5.6	18	54	14	10	15	-3.5
Wt	810	Marb +.13		REA +.04		Bfat +.01			
Prog.BW	52	BWt	WWt	WR	ADG	YWt	YR	Scr.	Fr.
WR	99	58	535	97	3.47	1050	101	36	5.0
YR	99								
Wean Pct.	61%								
Cow Eff.	129								

★★★★★ for Low Maintenance, Marbling, High Cow Efficiency, Calving Ease, Stayability.

190 **BSF EPITOMY W259 J2**
1-B 99% # 1331836 Tattoo: BSF9 W259

Birth: 3-17-09
 Beckton Epic K4 N795
BECKTON EPITOMY S250
 Ref. E-3
 Beckton Tara M635 JL
 Beckton Julian G1 J526
BSF JULIANNE R839 JL
 BSF Regus G340
 Beckton Epic KJ J722
 Beckton Sierra J789 EP
 Beckton Julian GG B571
 Beckton Tara J266 HR
 Beckton Julian GG B571
 Beckton Annie F743 LN
 Beckton Caesar M D023
 BSF Regus CB58

DAM		Calv.Ease	BW	WW	YW	Milk	HPG	Stay	Maint.En.
Age	4	15	-4.2	21	47	11	7	16	-3.3
Wt	980	Marb +.17		REA +.07		Bfat +.01			
Prog.BW	59	BWt	WWt	WR	ADG	YWt	YR	Scr.	Fr.
WR	97	66	549	92	3.42	1016	96	36	5.0
YR	99								
Wean Pct.	54%								
Cow Eff.	114								

★★★★★ for Low Maintenance, Marbling, Calving Ease, Stayability.

• Bulls •



193 **BSF JULIAN W597 J5**
 1-B 99% # 1331824 Tattoo: BSF9 W597

Birth: 4-3-09

Beckton Julian GG B571
 Beckton Julian 7526G
 Bkt Marta 9A13 JL

BECKTON JULIAN G3 P608
 Ref. J-3 Bkt Suffeina A828 DM
 Beckton Dominor 9455
 Bkt Suffeina 9493 TT

Beckton Julian G1 J526
 Beckton Julian GG B571
 Beckton Annie F743 LN

BSF JULIANNE R707 JL
 BSF Regus L568 LN
 Beckton Lancer T A664
 BSF Regus H166

DAM		Calv.Ease	BW	WW	YW	Milk	HPG	Stay	Maint.En.
Age	4	18	-5.9	23	47	12	9	16	-3.2
Wt	1065								
Prog.BW	65								
WR	103								
YR	103								
Wean Pct.	52%								
Cow Eff.	109								
		BWt	WWt	WR	ADG	YWt	YR	Scr.	Fr.
		67	573	96	2.97	1016	95	39	5.0

★★★★★ for Low Maintenance, Marbling, Rib-eye area, Calving Ease, Stayability.

191 **BSF ACTION W016 C2**
 1-B 99% # 1331979 Tattoo: BSF9 W016

Birth: 2-20-09

Beckton Cody K2 R168
 Beckton Cody KH M390
 Beckton Tamara K249 VG

BECKTON ACTION T061 D1
 Ref. C-2 Beckton Belga R716 DM
 Beckton Dominor ZC M919
 Beckton Belga K285 JL

Beckton Cody KH M390
 Beckton Tamara K249 VG

BSF JULESTE T792 CD
 BSF Juleste R644 JE
 Beckton Jules L429
 BSF Regus D616

DAM		Calv.Ease	BW	WW	YW	Milk	HPG	Stay	Maint.En.
Age	2	13	-3.7	30	64	18	12	14	-4.1
Wt	745								
Prog.BW	60								
WR	95								
YR	97								
Wean Pct.	60%								
Cow Eff.	127								
		BWt	WWt	WR	ADG	YWt	YR	Scr.	Fr.
		60	509	95	3.33	962	97	33	4.5

★★★★★ for Low Maintenance, Rib-eye area, High Cow Efficiency, Calving Ease, Stayability.

194 **BSF NEBULA W067 J4**
 1-B 99% # 1331976 Tattoo: BSF9 W067

Birth: 3-1-09

Beckton Nebula L P093
 Beckton Nebula M045
 Beckton Marta M021 LN

BECKTON NEBULA T398 V3
 Ref. N-11 Beckton Minerva J615 VG
 Beckton Vegas PK F485
 Beckton Minerva F433 VG

Beckton Julio L233
 Beckton Julian G1 J526
 Beckton Rose J725 EP

BSF JUSTICIA T700 JO
 BSF Justicia P007
 Beckton Justice CH M056
 BSF Regus M024 HR

DAM		Calv.Ease	BW	WW	YW	Milk	HPG	Stay	Maint.En.
Age	2	11	-1.1	32	60	11	9	14	-7.6
Wt	775								
Prog.BW	66								
WR	102								
YR	98								
Wean Pct.	63%								
Cow Eff.	132								
		BWt	WWt	WR	ADG	YWt	YR	Scr.	Fr.
		66	547	102	3.20	972	98	38	5.0

★★★★★ for Low Maintenance, High Cow Efficiency, Calving Ease, Stayability.

192 **BSF EMPEROR W647 J3**
 1-B 99% # 1331939 Tattoo: BSF9 W647

Birth: 4-7-09

Beckton Emperor R100
 Beckton Epic K4 N795
 Beckton Tamara N180 JO

BECKTON EMPEROR T641 E2
 Ref. E-6 Beckton Vernice R416 EP
 Beckton Epic K3 M606
 Beckton Vernice K482 HD

Beckton Justice CH M056
 Beckton Tamara M878 JC

BSF JUSTICIA T087 JC
 BSF Justicia R147 JC
 Beckton Justice C K449
 BSF Regus J698

DAM		Calv.Ease	BW	WW	YW	Milk	HPG	Stay	Maint.En.
Age	2	13	-4.3	33	70	18	9	15	3.5
Wt	805								
Prog.BW	54								
WR	118								
YR	109								
Wean Pct.	71%								
Cow Eff.	149								
		BWt	WWt	WR	ADG	YWt	YR	Scr.	Fr.
		54	631	118	3.60	1078	109	37	5.0

★★★★★ for Low Maintenance, Growth, Marbling, Rib-eye area, Superior Cow, High Cow Efficiency, Calving Ease, Stayability.

195 **BSF CLIFFTOP W825 H3**
 1-B 99% # 1331675 Tattoo: BSF9 W825

Birth: 4-26-09

Beckton Clifftop T C075
 BJR Topper 5241
 Beckton Barmaid A761 TR

BKT CLIFFTOP TP R288
 Ref. B-1 Beckton Christy K209 CO
 Beckton Copper JT G095
 Beckton Christy A111 VQ

Beckton Harmony K049
 Beckton Champ R3 H338
 Beckton Emera H568 LN

BSF REGUS M098 HA
 BSF Regus K090 CH
 Beckton Champ R1 H024
 BSF Regus H402

DAM		Calv.Ease	BW	WW	YW	Milk	HPG	Stay	Maint.En.
Age	7	10	-1.9	23	49	14	9	14	-1.6
Wt	1195								
Prog.BW	72								
WR	98								
YR	98								
Wean Pct.	46%								
Cow Eff.	97								
		BWt	WWt	WR	ADG	YWt	YR	Scr.	Fr.
		83	548	94	3.29	1013	95	37	5.0

★★★★★ for Low Maintenance, Calving Ease, Stayability.

• Bulls •

196 **BSF LOKI W220 W4**
1-B 99% # 1331710 Tattoo: BSF9 W220

Birth: 3-15-09
 Beckton Loki C M740
BECKTON LOKI CL S284
 Ref. L-2
 Beckton Lakme J460 LT
 Beckton Loki F251
 BKT Larkeisa J051 CK
 Beckton Latigo G714
 Beckton Lakme G128 HD
 Beckton Warrior TC E801
 Beckton Minerva B609 RN
 Beckton Hadrian A100
 BSF Regus 8183-2
BSF WENDIE N343 WR
 Beckton Warrior T1 H281
 BSF Regus E323

DAM		Calv.Ease	BW	WW	YW	Milk	HPG	Stay	Maint.En.
Age	6	16	-5.7	22	46	12	12	10	0.9
Wt	1145								
Prog.BW	66								
WR	100								
YR	100								
Wean Pct.	49%								
Cow Eff.	103								
		Marb			REA				Bfat
		BWt	WWt	WR	ADG	YWt	YR	Scr.	Fr.
		60	560	96	2.97	993	93	37	5.0

★★★★★ for Low Maintenance, Calving Ease.

198 **BECKTON JULIAN W711 D5**
1-A 100% # 1332298 Tattoo: BKT9 W711

Birth: 4-14-09
 Beckton Julian GJ P535
BECKTON JULIAN G5 S107
 Ref. J-5
 Beckton Minola P826 DM
 Beckton Julian 7526G
 Beckton Mona D086 JL
 Beckton Dominor ZC M919
 Beckton Minola M641 WR
 Beckton Dominor Z E401
 Beckton Barmaid J012 CO
 Beckton Warrior T1 H281
 Beckton Lana K237 EP
BECKTON LANA S742 DM
 Beckton Dominor ZC M919
 Beckton Lana N473 WR

DAM		Calv.Ease	BW	WW	YW	Milk	HPG	Stay	Maint.En.
Age	3	9	-1.0	36	81	15	12	16	1.2
Wt	925								
Prog.BW	69								
WR	116								
YR	111								
Wean Pct.	66%								
Cow Eff.	140								
		Marb			REA				Bfat
		BWt	WWt	WR	ADG	YWt	YR	Scr.	Fr.
		73	654	116	3.78	1138	111	37	5.0

★★★★★ for Low Maintenance, Growth, Marbling, Superior Cow, High Cow Efficiency, Calving Ease, Stayability.

197 **BSF WARRIOR W652 C4**
1-B 99% # 1331928 Tattoo: BSF9 W652

Birth: 4-8-09
 Beckton Warrior CL M686
BECKTON WARRIOR C1 S337
 Ref. W-2
 Beckton Christy K101 CD
 Beckton Warrior C C355
 Beckton Christy J223 LN
 Beckton Cody V E023
 Beckton Christy C306 JL
 Beckton Champ RH F275
 Beckton Lana F138 LN
 Beckton Jules L429
 BSF Regus L683 CT
BSF JEWEL S875 CH
 Beckton Champ R1 H024
 BSF Jewel N355 JE

DAM		Calv.Ease	BW	WW	YW	Milk	HPG	Stay	Maint.En.
Age	3	16	-5.4	23	51	15	12	13	-3.4
Wt	860								
Prog.BW	59								
WR	97								
YR	101								
Wean Pct.	58%								
Cow Eff.	123								
		Marb			REA				Bfat
		BWt	WWt	WR	ADG	YWt	YR	Scr.	Fr.
		60	540	96	3.51	1004	98	34	5.0

★★★★★ for Low Maintenance, Rib-eye area, High Cow Efficiency, Calving Ease, Stayability.

199 **BECKTON NEBULA W041 E4**
1-A 100% # 1332334 Tattoo: BKT9 W041

Birth: 2-24-09
 Beckton Nebula J R475
BECKTON NEBULA T054 H3
 Ref. N-9
 BKT Pine Marie R401 HU
 Beckton Nebula M045
 Beckton Larkeisa M138 JC
 Beckton Hustler C2 L079
 Bkt Pine Marie LC30 CD
 Beckton Epic K4 N795
 Beckton Tamara N180 JO
 Beckton Epic K F075
 Bkt Suffeina A828 DM
BKT SUFFEINA T121 EM
 Beckton Emperor R100
 BKT Suffeina R312 EP

DAM		Calv.Ease	BW	WW	YW	Milk	HPG	Stay	Maint.En.
Age	2	12	-3.7	27	60	13	10	16	-4.3
Wt	NA								
Prog.BW	57								
WR	105								
YR	99								
Wean Pct.	NA%								
Cow Eff.	NA								
		Marb			REA				Bfat
		BWt	WWt	WR	ADG	YWt	YR	Scr.	Fr.
		57	547	105	4.23	997	99	37	4.5

★★★★★ for Low Maintenance, Gainability, Marbling, Rib-eye area, Calving Ease, Stayability.



200 **BECKTON CLIFFTOP W598 N3**
1-A 100% # 1331863 Tattoo: BSF9 W598

Birth: 4-4-09
 Beckton Clifftop T C075
BKT CLIFFTOP TP R288
 Ref. B-1
 Beckton Christy K209 CO
 Beckton Nebula E P084
BECKTON ANNIE S206 NB
 Beckton Annie P151 WR
 BJR Topper 5241
 Beckton Barmaid A761 TR
 Beckton Copper JT G095
 Beckton Christy A111 VQ
 Beckton Nebula M045
 BKT Pine Marie M119 EP
 Beckton Warrior TD L493
 Beckton Annie F743 LN

DAM		Calv.Ease	BW	WW	YW	Milk	HPG	Stay	Maint.En.
Age	3	12	-3.4	26	57	15	9	15	-5.2
Wt	900								
Prog.BW	71								
WR	99								
YR	98								
Wean Pct.	59%								
Cow Eff.	124								
		Marb			REA				Bfat
		BWt	WWt	WR	ADG	YWt	YR	Scr.	Fr.
		71	568	103	3.65	1066	102	34	4.5

★★★★★ for Low Maintenance, Marbling, Rib-eye area, High Cow Efficiency, Calving Ease, Stayability.



201 BECKTON NEBULA W632 C3

1-A 100% # 1331785 Tattoo: BSF9 W632

Birth: 4-6-09

Beckton Nebula M045
Beckton Neptune R2 K065
Beckton Belga K285 JL

BECKTON NEBULA H R233
Ref. N-4
Beckton Coca H132 HD
Beckton Hadrian F C486
Beckton Coca CB74 JV

Beckton Clifftop T3 N800
Bkt Clifftop TV G672
Beckton Lana J384 CD

BECKTON ANGEL R155 CT
Beckton Angel N150 LN
Beckton Lancer T5 L095
Beckton Angel L717 LN

DAM		Calv.Ease	BW	WW	YW	Milk	HPG	Stay	Maint.En.
Age	4	15	-5.0	20	47	12	11	13	-3.6
Wt	1015	Marb +1.0		REA +0.09		Bfat +0.00			
Prog.BW	71	BWt	WWt	WR	ADG	YWt	YR	Scr.	Fr.
WR	93	71	557	94	3.60	1042	98	35	5.0
YR	94								
Wean Pct.	53%								
Cow Eff.	111								

★★★★★ for Low Maintenance, Calving Ease, Stayability.

202 BECKTON WARRIOR W146 E6

1-A 100% # 1332401 Tattoo: BKT9 W146

Birth: 3-9-09

Beckton Warrior N645 T1
Beckton Warrior T1 H281
Beckton Rose H074 EP

BECKTON WARRIOR T248 L5
Ref. W-3
Beckton Kit R503 LN
Beckton Lancer F442 T
Beckton Kit F468 JL

Beckton Epic K3 M606
Beckton Epic KJ J722
Beckton Lana F268 CT

BECKTON MAIATA T388 EP
Beckton Maiata M854 JC
Beckton Justice G302
Beckton Maiata C997 CB

DAM		Calv.Ease	BW	WW	YW	Milk	HPG	Stay	Maint.En.
Age	2	11	-3.1	25	51	9	9	15	-6.4
Wt	815	Marb +1.12		REA +0.23		Bfat +0.00			
Prog.BW	60	BWt	WWt	WR	ADG	YWt	YR	Scr.	Fr.
WR	102	60	544	102	3.33	1014	103	37	5.0
YR	103								
Wean Pct.	59%								
Cow Eff.	125								

★★★★★ for Low Maintenance, Marbling, Rib-eye area, High Cow Efficiency, Calving Ease, Stayability.

204 BECKTON ACCENT W588

1-A 100% # 1332004 Tattoo: BKT9 W588

Birth: 4-3-09

Beckton Cody KH M390
Beckton Cody K G701
Beckton Tamara J124 HR

BECKTON CODY K1 P014
Ref. C-1
Beckton Rose M126 WR
Beckton Warrior T C371
Beckton Rose D741 LN

Beckton Epic K F075
Beckton Epic D404
Beckton Belga D483 KR

BECKTON ROSE H074 EP
Beckton Rose F791 EM
Beckton Emperor C369
Beckton Rose C794 KR

DAM		Calv.Ease	BW	WW	YW	Milk	HPG	Stay	Maint.En.
Age	11	13	-5.9	19	47	19	7	12	1.0
Wt	1115	Marb +0.01		REA +0.09		Bfat +0.01			
Prog.BW	72	BWt	WWt	WR	ADG	YWt	YR	Scr.	Fr.
WR	107	64	585	98	2.93	1015	95	34	4.5
YR	104								
Wean Pct.	51%								
Cow Eff.	107								

★★★★★ for Low Maintenance, Superior Cow, Calving Ease.

203 BECKTON ACCENT W450

1-A 100% # 1332259 Tattoo: BKT9 W450

Birth: 3-26-09

Beckton Cody KH M390
Beckton Cody K G701
Beckton Tamara J124 HR

BECKTON CODY K1 P014
Ref. C-1
Beckton Rose M126 WR
Beckton Warrior T C371
Beckton Rose D741 LN

Beckton Lancer T7 M089
Beckton Lancer F442 T
Beckton Tamara G141 HE

BECKTON FIREFLY S418 LN
Beckton Firefly K250 VG
Beckton Vegas PK F485
Beckton Firefly E920 MB

DAM		Calv.Ease	BW	WW	YW	Milk	HPG	Stay	Maint.En.
Age	3	14	-6.2	18	45	19	7	12	2.2
Wt	985	Marb -0.05		REA +0.02		Bfat -0.02			
Prog.BW	66	BWt	WWt	WR	ADG	YWt	YR	Scr.	Fr.
WR	102	59	551	98	3.33	1009	98	36	5.0
YR	102								
Wean Pct.	52%								
Cow Eff.	109								

★★★★★ for Low Maintenance, Calving Ease.

205 BECKTON ROMAN W814

1-A 100% # 1332203 Tattoo: BKT9 W814

Birth: 4-24-09

TR Romeo NT379
Buffalo Creek Romeo L081
Buf Crk Lass L420

BECKTON ROMAN J S158
Ref. J-6
Beckton Belga K285 JL
Beckton Julian GG B571
Beckton Belga G493 HR

Beckton Jules L429
Beckton Julian G1 J526
Beckton Barona J591 EP

BECKTON LARKABA R615 JE
Beckton Larkaba M715 WR
Beckton Warrior C C355
Beckton Larkaba D388 SC

DAM		Calv.Ease	BW	WW	YW	Milk	HPG	Stay	Maint.En.
Age	4	13	-1.9	34	60	16	11	15	-5.4
Wt	960	Marb -0.01		REA +0.23		Bfat +0.01			
Prog.BW	62	BWt	WWt	WR	ADG	YWt	YR	Scr.	Fr.
WR	98	74	638	107	3.65	1076	101	33	5.0
YR	94								
Wean Pct.	64%								
Cow Eff.	135								

★★★★★ for Low Maintenance, Rib-eye area, High Cow Efficiency, Calving Ease, Stayability.

• Bulls •

206 BECKTON JUSTICE W560 L6
1-A 100% # 1332162 Tattoo: BKT9 W560

Birth: 4-1-09
 Beckton Justice C1 R483
BECKTON JUSTICE T124 C1
 Ref. J-7
 Beckton Scarlett R808 NB
 Beckton Justice CH M056
 Beckton Tamara J124 HR
 Beckton Nebula M045
 Andras Scarlett 2029
 Beckton Lancer F442 T
 Beckton Minola E589 TO
 Beckton Julio L233
 Beckton Tamara L888 NW
BECKTON TAMARA R160 LS
 Beckton Laser N602
 Beckton Tamara N421 JO

DAM		Calv.Ease	BW	WW	YW	Milk	HPG	Stay	Maint.En.
Age	4	16	-5.9	18	41	13	9	15	-11.0
Wt	860								
Prog.BW	60								
WR	95								
YR	93								
Wean Pct.	61%								
Cow Eff.	128								
		Marb			REA		Bfat		
		BWt	WWt	WR	ADG	YWt	YR	Scr.	Fr.
		62	542	91	3.42	964	91	37	5.0

★★★★★ for Low Maintenance, High Cow Efficiency, Calving Ease, Stayability.

209 BECKTON ACCENT W768 A2
1-A 100% # 1332223 Tattoo: BKT9 W768

Birth: 4-19-09
 Beckton Cody KH M390
BECKTON CODY K1 P014
 Ref. C-1
 Beckton Rose M126 WR
 Beckton Cody K G701
 Beckton Tamara J124 HR
 Beckton Warrior T C371
 Beckton Rose D741 LN
 Beckton Cody KH M390
 Beckton Rose M126 WR
 Beckton Lancer T4 J536
 Beckton Tamara H068 LN
BECKTON TAMARA S019 CD
 Beckton Cody K1 P014
 Beckton Tamara P460 LN

DAM		Calv.Ease	BW	WW	YW	Milk	HPG	Stay	Maint.En.
Age	3	17	-7.3	17	54	21	6	12	7.4
Wt	1010								
Prog.BW	55								
WR	104								
YR	103								
Wean Pct.	52%								
Cow Eff.	110								
		Marb			REA		Bfat		
		BWt	WWt	WR	ADG	YWt	YR	Scr.	Fr.
		54	567	101	3.78	1099	107	35	5.0

★★★★★ for Superior Cow, Calving Ease.

207 BECKTON NEBULA W239 H4
1-A 100% # 1332001 Tattoo: BKT9 W239

Birth: 3-16-09
 Beckton Nebula E P084
BECKTON NEBULA EN S347
 Ref. N-7
 Beckton Eola P530 NB
 Beckton Nebula M045
 BKT Pine Marie M119 EP
 Beckton Nebula M045
 Beckton Eola M663 EP
 Leachman Heavenly 8141
 Beckton Larkaba Z581 KR
 Beckton Neptune RT Z305
 Beckton Lana Z315 JL
BECKTON LANA G400 HR
 Beckton Herald K B244
 Beckton Lana D824 NP

DAM		Calv.Ease	BW	WW	YW	Milk	HPG	Stay	Maint.En.
Age	12	16	-6.0	17	28	13	12	13	-7.2
Wt	1115								
Prog.BW	78								
WR	107								
YR	103								
Wean Pct.	45%								
Cow Eff.	95								
		Marb			REA		Bfat		
		BWt	WWt	WR	ADG	YWt	YR	Scr.	Fr.
		60	524	88	3.20	936	88	39	4.5

★★★★★ for Low Maintenance, Marbling, Superior Cow, Calving Ease, Stayability.

210 BECKTON JUSTICE W549 H5
1-A 100% # 1332236 Tattoo: BKT9 W549

Birth: 3-31-09
 Beckton Justice CH M056
BECKTON JUSTICE C1 R483
 Ref. J-4
 Beckton Tamara J124 HR
 Beckton Justice C K449
 Beckton Ruth K802 HD
 Beckton Herald F FA20
 Beckton Tamara F183 CT
 Beckton Hustler C2 L079
 Beckton Lana L498 CO
 Beckton Julio L233
 Beckton Sierra J659 DM
BECKTON SIERRA S120 HW
 Beckton Hawk P248
 Beckton Sierra P348 JO

DAM		Calv.Ease	BW	WW	YW	Milk	HPG	Stay	Maint.En.
Age	3	14	-4.7	23	57	17	9	14	-1.3
Wt	855								
Prog.BW	68								
WR	102								
YR	104								
Wean Pct.	58%								
Cow Eff.	122								
		Marb			REA		Bfat		
		BWt	WWt	WR	ADG	YWt	YR	Scr.	Fr.
		62	536	95	3.83	1011	98	34	5.0

★★★★★ for Low Maintenance, High Cow Efficiency, Calving Ease, Stayability.

208 BECKTON NEBULA W548 J3
1-A 100% # 1332023 Tattoo: BKT9 W548

Birth: 3-31-09
 Beckton Nebula M045
BECKTON NEBULA L P093
 Ref. N-2
 Beckton Marta M021 LN
 Beckton Julian GG B571
BECKTON BELGA K285 JL
 Beckton Belga G493 HR
 Beckton Neptune R2 K065
 Beckton Belga K285 JL
 Beckton Lancer TA K644
 Beckton Marta K254 LN
 Beckton Julian 7526G
 Bkt Marta 9A13 JL
 Beckton Herald K B244
 Beckton Belga D776 CL

DAM		Calv.Ease	BW	WW	YW	Milk	HPG	Stay	Maint.En.
Age	NA	15	-3.2	32	60	8	14	14	-3.8
Wt	NA								
Prog.BW	66								
WR	101								
YR	101								
Wean Pct.	NA%								
Cow Eff.	NA								
		Marb			REA		Bfat		
		BWt	WWt	WR	ADG	YWt	YR	Scr.	Fr.
		70	569	106	3.06	967	94	34	4.5

★★★★★ for Low Maintenance, Rib-eye area, Calving Ease, Stayability.



• Bulls •

211 BECKTON NEBULA W515 L4
1-A 100% # 1331890 Tattoo: BSF9 W515

Birth: 3-29-09
 Beckton Nebula E P084
BECKTON NEBULA EN S347
 Ref. N-7
 Beckton Eola P530 NB
 Beckton Nebula M045
 BKT Pine Marie M119 EP
 Beckton Nebula M045
 Beckton Eola M663 EP
 Beckton Lancer T1 H080
 Beckton Ruth G534 NP
BECKTON KURUBA S452 LO
 Beckton Lasso P741
 Beckton Kuruba P296 LN
 Beckton Lancer T4 J536
 Beckton Kuruba L296 JL

DAM		Calv.Ease	BW	WW	YW	Milk	HPG	Stay	Maint.En.
Age	3	15	-5.2	19	46	10	10	15	-8.3
Wt	920	Marb +.22		REA +.02		Bfat +.00			
Prog.BW	62	BWt	WWt	WR	ADG	YWt	YR	Scr.	Fr.
WR	91	64	506	92	3.47	990	95	36	5.0
YR	96								
Wean Pct.	51%								
Cow Eff.	107								

★★★★★ for Low Maintenance, Marbling, Calving Ease, Stayability.

213 BECKTON JET W680 H2
1-A 100% # 1332239 Tattoo: BKT9 W680

Birth: 4-11-09
 TR Julian LT151
BECKTON JET L P491
 Ref. J-2
 Beckton Minerva L278 LN
 Beckton Julian GG B571
 MS Geometric 917
 Beckton Lancer TS D390
 Beckton Minerva F495 CH
 Beckton Hustler C2 L079
 Beckton Lana L498 CO
BECKTON BELGA S166 HW
 Beckton Hawk P248
 Beckton Belga P443 JO
 Beckton Julio L233
 Beckton Belga K117 LN

DAM		Calv.Ease	BW	WW	YW	Milk	HPG	Stay	Maint.En.
Age	3	16	-7.2	20	44	18	8	16	-0.2
Wt	990	Marb +.15		REA +.03		Bfat +.00			
Prog.BW	56	BWt	WWt	WR	ADG	YWt	YR	Scr.	Fr.
WR	106	55	585	102	3.15	1036	99	37	5.0
YR	101								
Wean Pct.	55%								
Cow Eff.	116								

★★★★★ for Low Maintenance, Marbling, High Cow Efficiency, Calving Ease, Stayability.



214 BECKTON JULIO W818 J2
1-A 100% # 1332140 Tattoo: BKT9 W818

Birth: 4-25-09
 Beckton Julian G1 J526
BECKTON JULIO L233
 Ref. J
 Beckton Rose J725 EP
 Beckton Julian GG B571
 Beckton Annie F743 LN
 Beckton Epic K F075
 Beckton Rose F192 CL
 Beckton Julian G1 J526
 Beckton Rose J725 EP
BECKTON SUFFEINA P778 JO
 Beckton Julio L233
 BKT Suffeina H693 LN
 Beckton Lancer T A664
 Bkt Suffeina D164 CL

DAM		Calv.Ease	BW	WW	YW	Milk	HPG	Stay	Maint.En.
Age	5	12	-2.5	25	53	10	5	18	-9.2
Wt	1070	Marb +.10		REA -.01		Bfat +.01			
Prog.BW	68	BWt	WWt	WR	ADG	YWt	YR	Scr.	Fr.
WR	98	80	574	99	3.20	1036	97	35	5.0
YR	97								
Wean Pct.	54%								
Cow Eff.	113								

★★★★★ for Low Maintenance, Calving Ease, Stayability.

212 BECKTON EPIC W838 E5
1-A 100% # 1332444 Tattoo: BKT9 W838

Birth: 4-29-09
 Beckton Epic KM M115
BECKTON EPIC K6 S569
 Ref. E-5
 Beckton Sierra N703 LM
 Beckton Epic KM M115
 Beckton Epic K F075
 Beckton Minerva F495 CH
 Beckton Laramie L044
 Beckton Sierra L887 LN
 Beckton Epic K F075
 Beckton Minerva F495 CH
BECKTON MONA T558 EP
 Beckton Vegas S1 K316
 Beckton Mona P199 VG
 Beckton Mona L618 LR

DAM		Calv.Ease	BW	WW	YW	Milk	HPG	Stay	Maint.En.
Age	2	10	-2.2	36	80	21	10	15	1.1
Wt	825	Marb +.13		REA -.01		Bfat +.01			
Prog.BW	65	BWt	WWt	WR	ADG	YWt	YR	Scr.	Fr.
WR	113	65	607	113	3.65	1096	111	36	5.0
YR	111								
Wean Pct.	66%								
Cow Eff.	140								

★★★★★ for Low Maintenance, Growth, Marbling, Superior Cow, High Cow Efficiency, Calving Ease, Stayability.

215 BECKTON EMPEROR W383 C3
1-A 100% # 1332422 Tattoo: BKT9 W383

Birth: 3-22-09
 Beckton Emperor R100
BECKTON EMPEROR T641 E2
 Ref. E-6
 Beckton Vernice R416 EP
 Beckton Emperor R100
 Beckton Epic K4 N795
 Beckton Tamara N180 JO
 Beckton Epic K3 M606
 Beckton Vernice K482 HD
 Bkt Clifftop TV G672
 Beckton Lana J384 CD
BECKTON MONA T480 CT
 Beckton Clifftop T3 N800
 Beckton Mona D086 JL
 Beckton Julian GV Z693
 Beckton Mona 9356 KR

DAM		Calv.Ease	BW	WW	YW	Milk	HPG	Stay	Maint.En.
Age	2	10	-2.5	26	60	13	7	13	0.3
Wt	845	Marb +.24		REA +.10		Bfat +.00			
Prog.BW	66	BWt	WWt	WR	ADG	YWt	YR	Scr.	Fr.
WR	100	66	536	100	3.74	1022	103	35	5.0
YR	103								
Wean Pct.	56%								
Cow Eff.	119								

★★★★★ for Low Maintenance, Marbling, High Cow Efficiency, Calving Ease, Stayability.

• Bulls •

216 BECKTON LANCER W698 N5
1-A 100% # 1332482 Tattoo: BKT9 W698

Birth: 4-13-09
 Beckton Lancer F442 T
 Beckton Lancer T A664
 Bkt Suffeina A828 DM
BECKTON LANCER T371 H4
 Ref. L-3 Beckton Coca F276 HV
 Leachman Heavenly 8141
 Beckton Coca B112 CB
 Beckton Neptune R1 J245
 Beckton Coca J276 CL
 Beckton Nexus L016
 Beckton Angel P390 JO
 Beckton Julio L233
 Beckton Angel G356 HR

DAM		Calv.Ease	BW	WW	YW	Milk	HPG	Stay	Maint.En.
Age	2	12	-2.5	36	72	16	8	12	4.3
Wt	NA	Marb		-0.2	REA		+0.8	Bfat	
Prog.BW	48								
WR	86								
YR	NA								
Wean Pct.	NA%	BWt	WWt	WR	ADG	YWt	YR	Scr.	Fr.
Cow Eff.	NA	58	517	97	3.87	1019	99	36	5.0

★★★★★ for Calving Ease.



217 BECKTON SUFFEINA W274 N
1-A 100% # 1332474 Tattoo: BKT9 W274

Birth: 3-18-09
 Beckton Nebula L P093
 Beckton Nebula M045
 Beckton Marta M021 LN
BECKTON NEBULA T252 L3
 Ref. N-10 Beckton Vernice L382 LN
 Beckton Lancer TZ D525
 Beckton Vernice G373 WR
 Beckton Nebula E P084
 Beckton Nebula M045
 BKT Pine Marie M119 EP
BKT SUFFEINA T724 NB
 Beckton Suffeina P603 JL
 Beckton Julian GG B571
 Bkt Suffeina A828 DM

DAM		Calv.Ease	BW	WW	YW	Milk	HPG	Stay	Maint.En.
Age	2	16	-4.8	24	53	11	10	18	-5.9
Wt	815	Marb		+1.5	REA		+1.2	Bfat	
Prog.BW	59								
WR	98								
YR	97								
Wean Pct.	57%	BWt	WWt	WR	ADG	YWt	YR	Scr.	Fr.
Cow Eff.	120	59	525	98	3.11	959	97	35	5.0

★★★★★ for Low Maintenance, Marbling, High Cow Efficiency, Calving Ease, Stayability.

219 BECKTON NEBULA W749 J3
1-A 100% # 1332292 Tattoo: BKT9 W749

Birth: 4-18-09
 Beckton Nebula M045
 Beckton Neptune R2 K065
 Beckton Belga K285 JL
BECKTON NEBULA G S237
 Ref. N-6 Beckton Lakme LA06 JL
 Beckton Julian GG B571
 Beckton Lakme B370 HV
 Beckton Julian GG B571
 Beckton Lana H544 WR
 Beckton Julian G2 M345
BECKTON CHRISTY S699 JL
 Beckton Christy C306 JL
 Beckton Julian 7526G
 Beckton Christy Z264 NP

DAM		Calv.Ease	BW	WW	YW	Milk	HPG	Stay	Maint.En.
Age	3	18	-4.8	21	48	7	13	14	-10.9
Wt	835	Marb		+1.0	REA		+1.5	Bfat	
Prog.BW	65								
WR	97								
YR	101								
Wean Pct.	57%	BWt	WWt	WR	ADG	YWt	YR	Scr.	Fr.
Cow Eff.	120	65	516	92	3.69	1001	97	34	5.0

★★★★★ for Low Maintenance, Rib-eye area, High Cow Efficiency, Calving Ease, Stayability.

218 BECKTON EMCEE W876 D2
1-A 100% # 1332257 Tattoo: BKT9 W876

Birth: 5-8-09
 Beckton Epic K4 N795
 Beckton Epic KJ J722
 Beckton Sierra J789 EP
BECKTON EMCEE S466
 Ref. E-4 Beckton Larkaba H798 WR
 Beckton Warrior T C371
 Beckton Larkaba E042 CD
 Beckton Dominor ZC M919
 Beckton Dominor Z E401
 Beckton Barmaid J012 CO
BECKTON LANA S371 DM
 Beckton Lana L367 LN
 Beckton Lancer F442 T
 Beckton Lana H143 JL

DAM		Calv.Ease	BW	WW	YW	Milk	HPG	Stay	Maint.En.
Age	3	11	-1.8	30	63	15	7	15	-2.2
Wt	980	Marb		+1.9	REA		+1.5	Bfat	
Prog.BW	70								
WR	102								
YR	102								
Wean Pct.	56%	BWt	WWt	WR	ADG	YWt	YR	Scr.	Fr.
Cow Eff.	118	73	587	102	3.51	1069	102	33	5.5

★★★★★ for Low Maintenance, Marbling, Rib-eye area, High Cow Efficiency, Calving Ease, Stayability. Selling ½ Interest & Full Possession.

220 BECKTON NEBULA W151 N4
1-A 100% # 1332394 Tattoo: BKT9 W151

Birth: 3-10-09
 Beckton Nebula L P093
 Beckton Nebula M045
 Beckton Marta M021 LN
BECKTON NEBULA T252 L3
 Ref. N-10 Beckton Vernice L382 LN
 Beckton Lancer TZ D525
 Beckton Vernice G373 WR
 Beckton Nebula L P093
 Beckton Nebula M045
 Beckton Marta M021 LN
BECKTON LANA T358 NB
 Beckton Lana M435 LN
 Beckton Lancer F442 T
 Beckton Lana H329 HD

DAM		Calv.Ease	BW	WW	YW	Milk	HPG	Stay	Maint.En.
Age	2	13	-2.8	33	64	10	9	15	-1.6
Wt	NA	Marb		+0.7	REA		+2.3	Bfat	
Prog.BW	64								
WR	97								
YR	96								
Wean Pct.	NA%	BWt	WWt	WR	ADG	YWt	YR	Scr.	Fr.
Cow Eff.	NA	64	515	97	4.19	945	96	33	5.0

★★★★★ for Low Maintenance, Gainability, Rib-eye area, Calving Ease, Stayability.

• Bulls •

221 BECKTON JULIAN W805 E5
1-A 100% # 1332278 Tattoo: BKT9 W805

Birth: 4-23-09
 Beckton Julian GJ P535
BECKTON JULIAN G5 S107
 Ref. J-5
 Beckton Minola P826 DM
 Beckton Julian 7526G
 Beckton Mona D086 JL
 Beckton Dominor ZC M919
 Beckton Minola M641 WR
 Beckton Epic KJ J722
 Beckton Sierra J789 EP
 Beckton Lancer TZ D525
 Beckton Vernice G373 WR
BECKTON VERNICE S585 EP
 Beckton Epic K4 N795
 Beckton Vernice L382 LN

DAM		Calv.Ease	BW	WW	YW	Milk	HPG	Stay	Maint.En.
Age	3	12	-3.1	30	69	12	6	16	3.5
Wt	1090	Marb +.20		REA +.11		Bfat +.00			
Prog.BW	60	BWt	WWt	WR	ADG	YWt	YR	Scr.	Fr.
WR	99	60	547	99	3.42	1020	98	37	5.0
YR	98								
Wean Pct.	47%								
Cow Eff.	98								

★★★★★ for Low Maintenance, Marbling, Calving Ease, Stayability.

224 BECKTON NEBULA W256 E2
1-A 100% # 1332495 Tattoo: BKT9 W256

Birth: 3-17-09
 Beckton Neptune R2 K065
BECKTON NEBULA M045
 Ref. N-1
 Beckton Belga K285 JL
 Beckton Neptune RR B284
 Beckton Lana C735 TP
 Beckton Julian GG B571
 Beckton Belga G493 HR
 Beckton Epic K F075
 Beckton Lana F891 JL
 Beckton Herald HH E503
 Beckton Tamara F170 NP
BECKTON TAMARA T841 EP
 Beckton Epic KJ J722
 Beckton Tamara J191 HR

DAM		Calv.Ease	BW	WW	YW	Milk	HPG	Stay	Maint.En.
Age	2	15	-5.3	22	44	11	11	11	-7.2
Wt	815	Marb +.05		REA -.07		Bfat +.01			
Prog.BW	51	BWt	WWt	WR	ADG	YWt	YR	Scr.	Fr.
WR	97	51	520	97	3.29	938	95	37	5.0
YR	95								
Wean Pct.	56%								
Cow Eff.	119								

★★★★★ for Low Maintenance, High Cow Efficiency, Calving Ease.

222 BECKTON NEBULA W724
1-A 100% # 1331874 Tattoo: BSF9 W724

Birth: 4-15-09
 Beckton Nebula E P084
BECKTON NEBULA EN S347
 Ref. N-7
 Beckton Eola P530 NB
 Beckton Nebula M045
 BKT Pine Marie M119 EP
 Beckton Nebula M045
 Beckton Eola M663 EP
 Beckton Cody K G701
 Beckton Tamara J124 HR
 Beckton Scamp T A825
 Beckton Mona J805 BH
BECKTON MONA S304 CD
 Beckton Cody KH M390
 Beckton Mona M250 SC

DAM		Calv.Ease	BW	WW	YW	Milk	HPG	Stay	Maint.En.
Age	3	18	-7.6	19	41	16	11	15	-5.0
Wt	865	Marb +.19		REA -.06		Bfat +.01			
Prog.BW	55	BWt	WWt	WR	ADG	YWt	YR	Scr.	Fr.
WR	106	55	605	106	2.88	1017	97	35	5.0
YR	97								
Wean Pct.	65%								
Cow Eff.	137								

★★★★★ for Low Maintenance, Marbling, High Cow Efficiency, Calving Ease, Stayability.



223 BECKTON DOMINOR W763 N5
1-A 100% # 1332206 Tattoo: BKT9 W763

Birth: 4-19-09
 Beckton Dominor ZC M919
BECKTON DOMINOR Z1 R610
 Ref. D-1
 Beckton Sierra K557 LO
 Beckton Dominor Z E401
 Beckton Barmaid J012 CO
 Beckton Loki F251
 Beckton Sierra C157 CL
 Beckton Neptune R2 K065
 Beckton Belga K285 JL
 Beckton Caesar M D023
 Beckton Coca E051 CL
BECKTON COCA R675 NB
 Beckton Nebula M045
 Beckton Coca H745 CS

DAM		Calv.Ease	BW	WW	YW	Milk	HPG	Stay	Maint.En.
Age	4	16	-5.9	23	51	16	9	16	-5.1
Wt	950	Marb +.13		REA +.15		Bfat +.01			
Prog.BW	62	BWt	WWt	WR	ADG	YWt	YR	Scr.	Fr.
WR	95	62	551	95	3.15	988	92	34	5.0
YR	93								
Wean Pct.	56%								
Cow Eff.	118								

★★★★★ for Low Maintenance, Marbling, Rib-eye area, High Cow Efficiency, Calving Ease, Stayability.

225 BECKTON EPIC W852 N5
1-A 100% # 1331946 Tattoo: BSF9 W852

Birth: 5-2-09
 Beckton Epic KM M115
BECKTON EPIC K6 S569
 Ref. E-5
 Beckton Sierra N703 LM
 Beckton Epic K F075
 Beckton Minerva F495 CH
 Beckton Laramie L044
 Beckton Sierra L887 LN
 Beckton Nebula M045
 BKT Pine Marie M119 EP
 Beckton Lancer F442 T
 Beckton Lana G248 HR
BECKTON LANA T148 NB
 Beckton Nebula E P084
 Beckton Lana M078 LN

DAM		Calv.Ease	BW	WW	YW	Milk	HPG	Stay	Maint.En.
Age	2	10	-1.7	32	64	17	10	17	-4.2
Wt	700	Marb +.15		REA +.12		Bfat +.00			
Prog.BW	68	BWt	WWt	WR	ADG	YWt	YR	Scr.	Fr.
WR	99	68	531	99	3.65	1022	103	36	5.0
YR	103								
Wean Pct.	67%								
Cow Eff.	142								

★★★★★ for Low Maintenance, Marbling, High Cow Efficiency, Calving Ease, Stayability.

The Yearling Heifers

The Beckton cowherd is a complete package of genetics for today's industry - moderately sized, efficient producers. They combine calving ease, growth, and desirable carcass traits. They are feminine, maternal and quiet, with nice udders. All of our heifer calves trailed up with their mothers into the Bighorn Mountains to spend their first summer. They have learned the meaning of mothering ability. Most impressively, heifers like these produce the bulls for our sale. We have included heifers from the very top of our replacements.

We are also pleased to have a very nice set of heifers from Tongue River Red Angus. These heifers carry are

selected with a similar philosophy, and carry a large influence of Beckton breeding. Both the Tongue River and the Beckton heifers have received a vaccination for lepto/vibrio this spring, but have not had MGA or other additives to suppress heat and influence gains. They have been through a complete breeding soundness exam, and are cycling and ready to breed.

We can keep any sale heifers and breed them in natural service to the same herd sires we use with our own heifers. There will be a charge of \$250 per heifer plus delivery at cost in the fall. Visit with Cam or Forest.



Special Offer

Beckton is offering 2 straws of semen from any Beckton sire (for which we have adequate supply) to go with each Beckton heifer purchased. Tongue River likewise is offering two straws for each Tongue River heifer purchased for sires. We can still offer 2 straws of Nebula P707, but for sires such as Julian B571 and LT751, for which supply is very limited, the offer is 1 free straw. The buyer will only be responsible for shipping costs from Billings, Mt. The buyer may use the semen on any animal he or she chooses.

• Heifers •

301 BECKTON LAKME W196 E
1-A 100% # 1331999 Tattoo: BKT9 W196

Birth: 3-13-09

Beckton Epic K F075
Beckton Epic D404
Beckton Belga D483 KR

BECKTON EPIC R350 K
Ref. E-2
Beckton Larkaba E042 CD
Beckton Cody C401
Beckton Larkaba C317 CL

Beckton Hadrian FC E166
Beckton Hadrian F C486
Bkt Pine Marie C046 CH

BECKTON LAKME G128 HD
Beckton Lakme E373 CL
Beckton Clipper KT C624
Beckton Lakme C030 HB

DAM		Calv.Ease	BW	WW	YW	Milk	HPG	Stay	Maint.En.
Age	12	12	-4.0	27	58	20	10	12	-0.4
Wt	1070	Marb	-.02	REA	+1.13	Bfat	+0.01	BWt	WR
Prog.BW	74					68	119	108	Fr.
WR	108								
YR	105								
Cow Eff.	109								

★★★★★ for Low Maintenance, Rib-eye area, Superior Cow, Calving Ease.

303 BECKTON INDIGO W744
1-A 100% # 1331645 Tattoo: BSF9 W744

Birth: 4-18-09

Beckton Cody K1 P014
Beckton Cody KH M390
Beckton Rose M126 WR

BECKTON COBALT S029
Ref. C
Beckton Marta P633 JO
Beckton Julio L233
Beckton Marta C314 JL

Beckton Copper JT G095
Beckton Copper J E616
Beckton Ruth E549 TP

BECKTON INDIGO K331 CO
Beckton Indigo F057 CL
Beckton Indigo D780 JL

DAM		Calv.Ease	BW	WW	YW	Milk	HPG	Stay	Maint.En.
Age	NA	12	-3.9	23	54	19	9	16	0.5
Wt	1200	Marb	-.01	REA	+0.07	Bfat	+0.01	BWt	WR
Prog.BW	71					68	112	110	Fr.
WR	108								
YR	104								
Cow Eff.	90								

★★★★★ for Low Maintenance, Superior Cow, Calving Ease, Stayability.



304 BECKTON TAMARA W296 S
1-A 100% # 1332297 Tattoo: BKT9 W296

Birth: 3-19-09

Beckton Scamp 8954
Beckton Julian 7526G
Bkt Kusi Annie 5462

BECKTON SCAMP T A825
Ref. J
Bkt Encino 8459 TJ
Beckton Trojan 7061P
BCH Kit 7132-784

Beckton Clifftop T3 N800
Beckton Clifftop TV G672
Beckton Lana J384 CD

BECKTON TAMARA S729 CT
Beckton Tamara M731 EP
Beckton Epic KJ J722
Beckton Tamara HA73 CH

DAM		Calv.Ease	BW	WW	YW	Milk	HPG	Stay	Maint.En.
Age	3	15	-5.6	17	42	17	8	11	-7.0
Wt	1035	Marb	+1.14	REA	-.13	Bfat	+0.01	BWt	WR
Prog.BW	61					60	107	105	Fr.
WR	107								
YR	105								
Cow Eff.	94								

★★★★★ for Low Maintenance, Marbling, Superior Cow, Calving Ease.

302 BECKTON LARKABA W263 A
1-A 100% # 1331601 Tattoo: BSF9 W263

Birth: 3-17-09

Beckton Cody KH M390
Beckton Cody K G701
Beckton Tamara J124 HR

BECKTON CODY K1 P014
Ref. C-1
Beckton Rose M126 WR
Beckton Warrior T C371
Beckton Rose D741 LN

Beckton Vegas P D462
Beckton Vegas 9433
Beckton Larkaba A442 PC

BECKTON LARKABA F394 VG
Beckton Larkaba D427 KR
Beckton Kaiser FD 9253
Beckton Larkaba A073 MB

DAM		Calv.Ease	BW	WW	YW	Milk	HPG	Stay	Maint.En.
Age	13	11	-3.0	24	47	17	7	12	-0.2
Wt	970	Marb	-.15	REA	+0.07	Bfat	-.01	BWt	WR
Prog.BW	73					75	105	102	Fr.
WR	102								
YR	99								
Cow Eff.	106								

★★★★★ for Low Maintenance, Calving Ease.

305 BECKTON VERNICE W161 E
1-A 100% # 1332186 Tattoo: BKT9 W161

Birth: 3-11-09

Beckton Epic K F075
Beckton Epic D404
Beckton Belga D483 KR

BECKTON EPIC R350 K
Ref. E-2
Beckton Larkaba E042 CD
Beckton Cody C401
Beckton Larkaba C317 CL

Beckton Epic K3 M606
Beckton Epic KJ J722
Beckton Lana F268 CT

BECKTON VERNICE R416 EP
Beckton Vernice K482 HD
Beckton Hadrian F C486
Beckton Vernice F513 CL

DAM		Calv.Ease	BW	WW	YW	Milk	HPG	Stay	Maint.En.
Age	4	11	-3.6	23	48	16	9	12	2.0
Wt	1095	Marb	+0.06	REA	+0.06	Bfat	+0.01	BWt	WR
Prog.BW	65					67	101	103	Fr.
WR	104								
YR	105								
Cow Eff.	90								

★★★★★ for Low Maintenance, Superior Cow, Calving Ease.

• Heifers •

306 **BECKTON SUSAN W474 J**
1-A 100% # 1332057 Tattoo: BKT9 W474

Birth: 3-27-09

Beckton Julian GG B571
Beckton Julian 7526G
Bkt Marta 9A13 JL

BECKTON JULIAN G3 P608
Ref. J-3
Bkt Suffeina A828 DM

Beckton Dominor 9455
Bkt Suffeina 9493 TT

Beckton Champ R1 H024
Beckton Champ RH F275
Beckton Lana F138 LN

BECKTON SUSAN M144 CH
Beckton Susan F315 TP
RDD B Topper 1675
Beckton Susan 9785VK

DAM		Calv.	Ease	BW	WW	YW	Milk	HPG	Stay	Maint.	En.
Age	7	15	-5.1	18	40	17	9	15	-3.2		
Wt	1175	Marb	+0.11	REA	+0.12	Bfat	-0.01	BWt	WR	YR	Fr.
Prog. BW	65					68	102	104			
WR	101										
YR	100										
Cow Eff.	88										

★★★★★ for Low Maintenance, Marbling, Calving Ease, Stayability.

309 **TR BRITTNEY WT926**
1-A 100% # 1324460 Tattoo: TR2A9 WT92

Birth: 2-22-09

Beckton Lancer F442 T
Beckton Lancer T A664
BKT Suffeina A828 DM

LJC JAVELIN M08
Ref.
LJC Logan E56 945

Glacier Logan 210
Buckeye Charlotte

TR Julian LT151
Beckton Julian GG B571
Ms Geometric 917

TR BRITTNEY RT543
TR Brittney NT316
Buf Crk Hobo 1961
Beckton Lana E828 SC

DAM		Calv.	Ease	BW	WW	YW	Milk	HPG	Stay	Maint.	En.
Age	4	8	-0.8	36	74	13	7	14	2.5		
Wt	1255	Marb	+0.17	REA	+0.24	Bfat	-0.01	BWt	WR	YR	Fr.
Prog. BW	72					76	111	115			
WR	114										
YR	114										
Cow Eff.	NA										

★★★★★ for Low Maintenance, Growth, Marbling, Rib-eye area, Superior Cow, Calving Ease, Stayability.

307 **BECKTON LANA W322 J**
1-A 100% # 1332058 Tattoo: BKT9 W322

Birth: 3-20-09

TR Julian LT151
Beckton Julian GG B571
MS Geometric 917

BECKTON JET L P491
Ref. J-2
Beckton Minerva L278 LN

Beckton Lancer TS D390
Beckton Minerva F495 CH

Beckton Lancer F442 T
Beckton Lancer T A664
Bkt Suffeina A828 DM

BECKTON LANA M167 LN
Beckton Lana J384 CD
Beckton Cody K G701
Beckton Lana G514 CD

DAM		Calv.	Ease	BW	WW	YW	Milk	HPG	Stay	Maint.	En.
Age	7	14	-4.8	24	46	16	7	15	0.7		
Wt	1140	Marb	+0.17	REA	+0.14	Bfat	+0.00	BWt	WR	YR	Fr.
Prog. BW	68					70	106	100			
WR	100										
YR	97										
Cow Eff.	94										

★★★★★ for Low Maintenance, Marbling, Rib-eye area, Calving Ease, Stayability.

310 **TR NELL WT914**
1-A 100% # 1324476 Tattoo: TR2A9 WT91

Birth: 2-18-09

Loosli Cherokee Teton 316N
Bfck Cherokee Cnyn 4912
Miss LL Divide 703

BUF CRK TETON R088
Ref. B
Buf Crk Hall N353

Beckton Lancer F442 T
Buf Crk Hall 6182A

Buf Crk Romeo L081
Beckton Julian GG B571
Buf Crk Primrose 5679

BUF CRK NELL P115
Buf Crk Nell L451
Buf Crk Dynamics 3820
Buf Crk Nell 1439

DAM		Calv.	Ease	BW	WW	YW	Milk	HPG	Stay	Maint.	En.
Age	5	9	-2.1	29	54	17	10	14	-4.5		
Wt	1370	Marb	+0.10	REA	+0.10	Bfat	+0.00	BWt	WR	YR	Fr.
Prog. BW	70					73	107	107			
WR	101										
YR	101										
Cow Eff.	NA										

★★★★★ for Low Maintenance, Calving Ease, Stayability.

308 **BECKTON BARMAID W235 J**
1-A 100% # 1331629 Tattoo: BSF9 W235

Birth: 3-16-09

TR Julian LT151
Beckton Julian GG B571
MS Geometric 917

BECKTON JET L P491
Ref. J-2
Beckton Minerva L278 LN

Beckton Lancer TS D390
Beckton Minerva F495 CH

Beckton Copper JT G095
Beckton Copper J E616
Beckton Ruth E549 TP

BECKTON BARMAID J012 CO
Beckton Barmaid G565 LN
Beckton Lancer T A664
Bkt Barmaid 9517 RN

DAM		Calv.	Ease	BW	WW	YW	Milk	HPG	Stay	Maint.	En.
Age	10	15	-6.7	17	41	20	8	17	-3.9		
Wt	1025	Marb	+0.26	REA	+0.04	Bfat	+0.01	BWt	WR	YR	Fr.
Prog. BW	70					64	105	107			
WR	103										
YR	107										
Cow Eff.	111										

★★★★★ for Low Maintenance, Marbling, Superior Cow, Calving Ease, Stayability.



• Heifers •

311 **TR COCA WT923**
1-A 100% # 1324456 Tattoo: TR2A9 WT92

Birth: 2-12-09

Beckton Julian GG B571
BKT Julian 7526 G
BKT Marta 9A13 JL

TR JULIAN LT151
Ref. J-10
Ms Geometric 917
BJR Yo 121
Ms Geometric

BKT Julian 7526 G
Beckton Julian 6592
BKT Belga 6746 GS

TR COCA RT527
Beckton Coca L388 CK
Beckton Colt G552
Beckton Coca G488 WR

DAM		Calv.Ease	BW	WW	YW	Milk	HPG	Stay	Maint.En.		
Age	4	14	-2.9	29	65	9	15	14	8.6		
Wt	1460										
Prog.BW	66										
WR	100										
YR	103										
Cow Eff.	NA										
		Marb	+0.16	REA	+0.12	Bfat	+0.01	BWt	WR	YR	Fr.
						70	100	105			

★★★★★ for Growth, Marbling, Calving Ease, Stayability.

313 **TR CEDAR WT934**
1-A 100% # 1324412 Tattoo: TR2A9 WT93

Birth: 2-4-09

Beckton Neptune R2 K065
Beckton Neptune RR B284
Beckton Lana C735 TP

BECKTON NEBULA M045
Ref. N-1
Beckton Belga K285 JL
Beckton Julian GG B571
Beckton Belga G493 HR

Beckton Lancer T A664
Beckton Lancer 9380
Beckton Coca 9119 TJ

TR CEDAR TT726
Ms Geometric 928
Algebra I 769
Ms Geometric 661

DAM		Calv.Ease	BW	WW	YW	Milk	HPG	Stay	Maint.En.		
Age	2	17	-6.2	25	57	10	11	11	-1.0		
Wt	1100										
Prog.BW	58										
WR	99										
YR	102										
Cow Eff.	NA										
		Marb	+0.12	REA	+0.12	Bfat	+0.00	BWt	WR	YR	Fr.
						58	99	102			

★★★★★ for Low Maintenance, Marbling, Calving Ease.

312 **TR CEDAR WT916**
1-A 100% # 1324445 Tattoo: TR2A9 WT91

Birth: 2-16-09

Beckton Epic K F075
Beckton Epic D404
Beckton Belga D483 KR

BECKTON EPIC KM M115
Ref. E
Beckton Minerva F495 CH
Beckton Champ R A583
Beckton Minerva CB69 JL

Beckton Lancer T A664
Beckton Lancer 9380
Beckton Coco 9119 TJ

TR CEDAR PT455
Ms Geometric 917
BJR Yo 121
Ms Geometric

DAM		Calv.Ease	BW	WW	YW	Milk	HPG	Stay	Maint.En.		
Age	5	11	-3.8	25	65	16	10	12	4.6		
Wt	1600										
Prog.BW	65										
WR	90										
YR	100										
Cow Eff.	NA										
		Marb	+0.21	REA	-0.08	Bfat	+0.01	BWt	WR	YR	Fr.
						66	84	101			

★★★★★ for Marbling, Calving Ease.

314 **TR LANA WT929**
1-A 100% # 1324469 Tattoo: TR2A9 WT92

Birth: 3-3-09

Loosli Cherokee Teton 316N
Bfck Cherokee Cnyn 4912
Miss LL Divide 703

BUF CRK TETON R088
Ref. B
Buf Crk Hall N353
Beckton Lancer F442 T
Buf Crk Hall 6182A

TR Julian LT151
Beckton Julian GG B571
Ms Geometric 917

TR LANA ST685
TR Lana PT460
Beckton Cody V E023
Beckton Lana E828 SC

DAM		Calv.Ease	BW	WW	YW	Milk	HPG	Stay	Maint.En.		
Age	3	14	-4.7	25	55	16	13	13	-1.1		
Wt	1240										
Prog.BW	62										
WR	101										
YR	104										
Cow Eff.	NA										
		Marb	+0.15	REA	+0.19	Bfat	-0.01	BWt	WR	YR	Fr.
						57	102	108			

★★★★★ for Low Maintenance, Marbling, Rib-eye area, Calving Ease, Stayability.



315 **TR LANA WT931**
1-A 100% # 1324404 Tattoo: TR2A9 WT93

Birth: 2-18-09

Beckton Nebula M045
Beckton Neptune R2 K065
Beckton Belga K285 JL

TR NEBULA TT779
Ref. N-12
TR Lydia MT244
Beckton Lancer F134 TS
Beckton Lydia E251 CL

Beckton Justice CH M056
Beckton Justice C K449
Beckton Ruth K802 HD

BECKTON LANA T679 JC
Beckton Lana L519 CH
Beckton Champ R3 H338
Beckton Lana H349 HR

DAM		Calv.Ease	BW	WW	YW	Milk	HPG	Stay	Maint.En.		
Age	2	7	0.8	39	70	15	12	12	-1.4		
Wt	1135										
Prog.BW	83										
WR	112										
YR	106										
Cow Eff.	NA										
		Marb	+0.09	REA	-0.01	Bfat	-0.01	BWt	WR	YR	Fr.
						83	112	106			

★★★★★ for Low Maintenance, Growth, Superior Cow, Calving Ease.

• Heifers •

316 **TR CARRIE WT937**
1-A 100% # 1324410 Tattoo: TR2A9 WT93

Birth: 2-18-09

Beckton Nebula M045
Beckton Neptune R2 K065
Beckton Belga K285 JL

TR NEBULA TT779
Ref. N-12 \ TR Lydia MT244

Beckton Lancer F134 TS
Beckton Lydia E251 CL

Beckton Neptune R2 K065
Beckton Belga K285 JL

TR CARRIE TT735
Beckton Nebula M045
TR Carrie RT524

TR Julian LT151
Buf Crk Carrie L349

DAM		Calv.	Ease	BW	WW	YW	Milk	HPG	Stay	Maint.	En.
Age	2	16	-5.1	26	58	13	13	13		-0.9	
Wt	1080	Marb	+0.15	REA	+0.07	Bfat	+0.00	BWt	WR	YR	Fr.
Prog. BW	57							57	101	105	
WR	101										
YR	105										
Cow Eff.	NA										

★★★★★ for Low Maintenance, Marbling, Calving Ease, Stayability.

319 **TR CEDAR WT928**
1-A 100% # 1324468 Tattoo: TR2A9 WT92

Birth: 3-25-09

Loosli Cherokee Teton 316N
Bfck Cherokee Cnyn 4912
Miss LL Divide 703

BUF CRK TETON R088
Ref. B \ Buf Crk Hall N353

Beckton Lancer F442 T
Buf Crk Hall 6182A

Beckton Julian GG B571
TR Lana G760

Beckton Lancer T A664
Ms Geometric 917

TR Julian LT142
TR Cedar PT455

DAM		Calv.	Ease	BW	WW	YW	Milk	HPG	Stay	Maint.	En.
Age	3	16	-5.2	24	51	16	12	14		-6.5	
Wt	1165	Marb	+0.26	REA	+0.21	Bfat	-0.01	BWt	WR	YR	Fr.
Prog. BW	62							57	96	104	
WR	105										
YR	108										
Cow Eff.	NA										

★★★★★ for Low Maintenance, Marbling, Rib-eye area, Superior Cow, Calving Ease, Stayability.

317 **TR THISTLE WT919**
1-A 100% # 1324473 Tattoo: TR2A9 WT91

Birth: 2-22-09

Beckton Julian GG B571
BKT Julian 7526 G
BKT Marta 9A13 JL

TR JULIAN LT151
Ref. J-10 \ Ms Geometric 917

BJR Yo 121
Ms Geometric

Beckton Julian GG B571
Buf Crk Primrose 5679

Buf Crk Romeo L081
Beckton Lancer TH K417
Beckton Tamara E193 CO

THIS OF N441 ROMEO
Beckton Tamara N441 LN

DAM		Calv.	Ease	BW	WW	YW	Milk	HPG	Stay	Maint.	En.
Age	3	9	-1.9	34	73	17	12	14		7.6	
Wt	1605	Marb	+0.12	REA	+0.11	Bfat	+0.01	BWt	WR	YR	Fr.
Prog. BW	75							60	NA	NA	
WR	102										
YR	101										
Cow Eff.	NA										

★★★★★ for Marbling, Calving Ease, Stayability.



318 **TR LASS WT904**
1-A 100% # 1324425 Tattoo: TR2A9 WT90

Birth: 3-13-09

Beckton Nebula M045
Beckton Neptune R2 K065
Beckton Belga K285 JL

TR NEBULA TT779
Ref. N-12 \ TR Lydia MT244

Beckton Lancer F134 TS
Beckton Lydia E251 CL

Buf Crk Julesburg 5807
Buf Crk Julian 4942
Buf Crk Vesta 3436

BUF CRK LASS L011A
Buf Crk Lass 5545

Beckton Lancer G575 T
Buf Crk Lass 4773

DAM		Calv.	Ease	BW	WW	YW	Milk	HPG	Stay	Maint.	En.
Age	8	11	-2.2	29	51	14	14	13		-2.5	
Wt	1390	Marb	+0.07	REA	+0.13	Bfat	+0.00	BWt	WR	YR	Fr.
Prog. BW	82							74	105	101	
WR	103										
YR	99										
Cow Eff.	NA										

★★★★★ for Low Maintenance, Rib-eye area, Calving Ease, Stayability.

320 **BSF JULIANNE W262 H**
1-B 99% # 1331738 Tattoo: BSF9 W262

Birth: 3-17-09

Beckton Hasten P292
Beckton Hustler C2 L079
Beckton Sheba L644 CH

BECKTON HASTEN H S462
Ref. H-2 \ Beckton Lakme G128 HD

Beckton Hadrian FC E166
Beckton Lakme E373 CL

Beckton Julian G2 M345
Beckton Julian GG B571
Beckton Lana H544 WR

BSF JULIANNE P152
BSF Regus M352 CD

Beckton Cody K G701
BSF Regus E738

DAM		Calv.	Ease	BW	WW	YW	Milk	HPG	Stay	Maint.	En.
Age	5	16	-5.2	27	53	16	10	12		-3.9	
Wt	870	Marb	+0.06	REA	+0.02	Bfat	-0.01	BWt	WR	YR	Fr.
Prog. BW	61							63	99	106	
WR	100										
YR	104										
Cow Eff.	115										

★★★★★ for Low Maintenance, Calving Ease.

• Heifers •

321 BECKTON LARKABEL W215 J
1-A 100% # 1331752 Tattoo: BSF9 W215

Birth: 3-14-09

Beckton Julian GG B571
BECKTON JULIAN G3 P608
 Ref. J-3
 Bkt Suffeina A828 DM

Beckton Julian 7526G
 Bkt Marta 9A13 JL

Beckton Dominor 9455
 Bkt Suffeina 9493 TT

Beckton Cody KH M390
BECKTON LARKABEL P425 CD
 BKT Larkabel M166 LN

Beckton Cody K G701
 Beckton Tamara J124 HR

Beckton Lancer TS D390
 Bkt Larkabel G030 CT

DAM		Calv.Ease	BW	WW	YW	Milk	HPG	Stay	Maint.En.
Age	5	20	-7.8	14	36	13	10	15	-6.9
Wt	1085								
Prog.BW	54								
WR	92								
YR	95								
Cow Eff.	91								

Marb **+1.0** REA **-0.9** Bfat **+0.1** BWt **55** WR **98** YR **100**

★★★★★ for Low Maintenance, Calving Ease, Stayability.

324 BECKTON TAMARA W088 C
1-A 100% # 1332034 Tattoo: BKT9 W088

Birth: 3-3-09

Beckton Clifftop T C075
BKT CLIFFTOP TP R288
 Ref. B-1
 Beckton Christy K209 CO

BJR Topper 5241
 Beckton Barmaid A761 TR

Beckton Copper JT G095
 Beckton Christy A111 VQ

Beckton Lancer TS D390
BECKTON TAMARA L214 LN
 Beckton Tamara A023 BF

Beckton Lancer T A664
 Beckton Coca 7536 SB

BUF CRK 27M-1255
 Bkt Tamara 9857 VK

DAM		Calv.Ease	BW	WW	YW	Milk	HPG	Stay	Maint.En.
Age	8	12	-4.2	21	43	18	5	13	-1.6
Wt	1145								
Prog.BW	75								
WR	102								
YR	102								
Cow Eff.	91								

Marb **+0.4** REA **-0.5** Bfat **-0.1** BWt **70** WR **103** YR **99**

★★★★★ for Low Maintenance, Calving Ease, Stayability.

322 BECKTON LARKABEL W261 W
1-A 100% # 1331676 Tattoo: BSF9 W261

Birth: 3-17-09

Beckton Warrior CL M686
BECKTON WARRIOR C1 S337
 Ref. W-2
 Beckton Christy K101 CD

Beckton Warrior C C355
 Beckton Christy J223 LN

Beckton Cody V E023
 Beckton Christy C306 JL

Beckton Lancer TS D390
BKT LARKABEL M166 LN
 Bkt Larkabel G030 CT

Beckton Lancer T A664
 Beckton Coca 7536 SB

Beckton Clifftop TC E081
 Bkt Larkabel E645 MB

DAM		Calv.Ease	BW	WW	YW	Milk	HPG	Stay	Maint.En.
Age	7	16	-5.1	23	44	15	11	13	-3.4
Wt	1060								
Prog.BW	70								
WR	101								
YR	100								
Cow Eff.	96								

Marb **+0.7** REA **-0.2** Bfat **-0.1** BWt **67** WR **100** YR **100**

★★★★★ for Low Maintenance, Calving Ease, Stayability.

325 BSF JULIANNE W435 A
2 50% # 1331747 Tattoo: BSF9 W435

Birth: 3-25-09

Beckton Cody KH M390
BECKTON CODY K1 P014
 Ref. C-1
 Beckton Rose M126 WR

Beckton Cody K G701
 Beckton Tamara J124 HR

Beckton Warrior T C371
 Beckton Rose D741 LN

Beckton Julian G2 M345
BSF JULIANNE P332
 BSF Regus M835 JL

Beckton Julian GG B571
 Beckton Lana H544 WR

Beckton Julian 7526G
 BSF Regus H052

DAM		Calv.Ease	BW	WW	YW	Milk	HPG	Stay	Maint.En.
Age	5	17	-5.2	17	50	13	9	14	4.3
Wt	1085								
Prog.BW	56								
WR	98								
YR	103								
Cow Eff.	89								

Marb **+0.5** REA **+0.9** Bfat **-0.1** BWt **60** WR **96** YR **106**

★★★★★ for Calving Ease, Stayability.

323 BECKTON MINERVA W275 N
1-A 100% # 1332038 Tattoo: BKT9 W275

Birth: 3-18-09

Beckton Nebula E P084
BECKTON NEBULA EN S347
 Ref. N-7
 Beckton Eola P530 NB

Beckton Nebula M045
 BKT Pine Marie M119 EP

Beckton Nebula M045
 Beckton Eola M663 EP

Beckton Lancer T3 J396
BECKTON MINERVA L324 LN
 Beckton Minerva J232 LN

Beckton Lancer TL G626
 Beckton Angel G356 HR

Beckton Lancer TS D390
 Beckton Minerva F495 CH

DAM		Calv.Ease	BW	WW	YW	Milk	HPG	Stay	Maint.En.
Age	8	16	-5.8	20	42	17	9	16	-7.3
Wt	1110								
Prog.BW	71								
WR	103								
YR	106								
Cow Eff.	91								

Marb **+0.24** REA **-0.9** Bfat **+0.0** BWt **67** WR **100** YR **100**

★★★★★ for Low Maintenance, Marbling, Calving Ease, Stayability.



• Heifers •

326 **BECKTON ROSE W145 N**
1-A 100% # 1331780 Tattoo: BSF9 W145

Birth: 3-9-09

Beckton Nomad 7496
Beckton Neva 5562
Bkt Bolt Tamrck 3913

BECKTON NOMAD T 9A14
Ref. V

Beckton Lana 7152 TJ
Beckton Trojan 5253
Bkt Signal Lana 5599

Beckton Lancer T9 N586
Beckton Lancer TA K644
BKT Larkeisa H232 SC

BECKTON ROSE R114 LN

Beckton Rose N375 LN
Beckton Lancer TH K417
Beckton Rose D731 CB

DAM		Calv.Ease	BW	WW	YW	Milk	HPG	Stay	Maint.En.		
Age	4	15	-4.6	15	34	8	11	10	-5.3		
Wt	1065	Marb	+0.1	REA	-0.12	Bfat	-0.01	BWt	WR	YR	Fr.
Prog.BW	63							67	103	99	
WR	106										
YR	102										
Cow Eff.	95										

★★★★★ for Low Maintenance, Calving Ease.

329 **TR LANA WT912**
1-A 100% # 1324442 Tattoo: TR2A9 WT91

Birth: 2-24-09

Beckton Julian GG B571
BKT Julian 7526 G
BKT Marta 9A13 JL

TR JULIAN LT151
Ref. J-10

Ms Geometric 917
BJR Yo 121
Ms Geometric

Beckton Epic D404
Beckton Saga KJ B702
Beckton Kuruba B508 PC

TR LANA NT329

TR Lana LT116
Beckton Lancer F134 TS
Beckton Lana E828 SC

DAM		Calv.Ease	BW	WW	YW	Milk	HPG	Stay	Maint.En.		
Age	6	11	-1.9	26	56	12	12	16	3.2		
Wt	1445	Marb	+0.20	REA	+0.12	Bfat	+0.01	BWt	WR	YR	Fr.
Prog.BW	77							80	97	99	
WR	103										
YR	104										
Cow Eff.	NA										

★★★★★ for Low Maintenance, Marbling, Superior Cow, Calving Ease, Stayability.

327 **BECKTON EOLA W624 J**
1-A 100% # 1332082 Tattoo: BKT9 W624

Birth: 4-6-09

Beckton Justice C1 R483
Beckton Justice CH M056
Beckton Tamara J124 HR

BECKTON JUSTICE T124 C1
Ref. J-7

Beckton Scarlett R808 NB
Beckton Nebula M045
Andras Scarlett 2029

Beckton Warrior TD L493
Beckton Warrior T C371
Bkt Suffeina A828 DM

BECKTON EOLA N072 WR

Beckton Eola L544 WR
Beckton Warrior T2 J333
Beckton Eola J239 CH

DAM		Calv.Ease	BW	WW	YW	Milk	HPG	Stay	Maint.En.		
Age	6	10	-1.2	30	68	16	10	11	0.7		
Wt	1160	Marb	+0.11	REA	+0.03	Bfat	-0.01	BWt	WR	YR	Fr.
Prog.BW	72							79	98	100	
WR	103										
YR	104										
Cow Eff.	86										

★★★★★ for Low Maintenance, Marbling, Superior Cow, Calving Ease.

330 **TR COCA WT906**
1-A 100% # 1324427 Tattoo: TR2A9 WT90

Birth: 3-5-09

Loosli Cherokee Teton 316N
Bfck Cherokee Cnyn 4912
Miss LL Divide 703

BUF CRK TETON R088
Ref. B

Buf Crk Hall N353
Beckton Lancer F442 T
Buf Crk Hall 6182A

Beckton Colt G552
Beckton Clipper KC D400
Beckton Rose Z519 ZN

BECKTON COCA L388 CK

Beckton Coco G488 WR
Beckton Warrior T C371
Beckton Coca D185 RD

DAM		Calv.Ease	BW	WW	YW	Milk	HPG	Stay	Maint.En.		
Age	8	7	0.1	33	63	12	11	11	1.6		
Wt	1540	Marb	+0.12	REA	+0.11	Bfat	-0.01	BWt	WR	YR	Fr.
Prog.BW	74							84	99	100	
WR	98										
YR	104										
Cow Eff.	NA										

★★★★★ for Low Maintenance, Marbling, Calving Ease.

328 **BECKTON ENCINO W332 J**
1-A 100% # 1332168 Tattoo: BKT9 W332

Birth: 3-20-09

Beckton Justice CH M056
Beckton Justice C K449
Beckton Ruth K802 HD

BECKTON JUSTICE C1 R483
Ref. J-4

Beckton Tamara J124 HR
Beckton Herald F FA20
Beckton Tamara F183 CT

Beckton Justice CH M056
Beckton Justice C K449
Beckton Ruth K802 HD

BECKTON ENCINO R207 JC

Beckton Encino G238 BR
Beckton Brutus T E062
Beckton Encino E821 JL

DAM		Calv.Ease	BW	WW	YW	Milk	HPG	Stay	Maint.En.		
Age	4	17	-6.1	21	53	18	11	12	3.3		
Wt	970	Marb	+0.10	REA	+0.06	Bfat	-0.01	BWt	WR	YR	Fr.
Prog.BW	61							54	100	96	
WR	108										
YR	106										
Cow Eff.	100										

★★★★★ for Low Maintenance, Superior Cow, Calving Ease.

331 **TR BRANDY WT935**
1-A 100% # 1324413 Tattoo: TR2A9 WT93

Birth: 2-2-09

Beckton Epic K F075
Beckton Epic D404
Beckton Belga D483 KR

TR EPIC ST618
Ref. E-7

Beckton Kit F468 JL
Beckton Julian GG B571
Beckton Kit A517 NP

TR Julian LT151
Beckton Julian GG B571
Ms Geometric 917

TR EOLA TT727

TR Eola NT301
Beckton Clifftop T C075
Beckton Eola E567 JL

DAM		Calv.Ease	BW	WW	YW	Milk	HPG	Stay	Maint.En.		
Age	2	14	-4.3	22	48	11	12	15	0.9		
Wt	1150	Marb	+0.10	REA	+0.23	Bfat	+0.01	BWt	WR	YR	Fr.
Prog.BW	60							60	91	97	
WR	91										
YR	97										
Cow Eff.	NA										

★★★★★ for Low Maintenance, Rib-eye area, Calving Ease, Stayability.

• Heifers •



334 **TR CEDAR WT936**
 1-A 100% # 1324415 Tattoo: TR2A9 WT93
 Birth: 3-2-09

Beckton Nebula M045
TR NEBULA TT779
 Ref. N-12 \ TR Lydia MT244

Beckton Neptune R2 K065
 Beckton Belga K285 JL
 Beckton Lancer F134 TS
 Beckton Lydia E251 CL
 Bfck Cherokee Cnyn 4912
 BKT Marta 9A13 JL

Mr. R2R Marvel A13N3
TR CEDAR TT732
 \ TR Cedar RT516

BSF Julian JT911
 Ms Geometric 027

DAM		Calv.Ease	BW	WW	YW	Milk	HPG	Stay	Maint.En.
Age	2	13	-2.4	26	48	13	11	13	-5.8
Wt	935								
Prog.BW	64								
WR	95								
YR	94								
Cow Eff.	NA	Marb +.08	REA +.04	Bfat +.00		BWt 64	WR 95	YR 94	Fr.

★★★★★ for Low Maintenance, Calving Ease, Stayability.

332 **TR WILLOW WT933**
 1-A 100% # 1324408 Tattoo: TR2A9 WT93
 Birth: 2-1-09

Beckton Nebula M045
TR NEBULA TT779
 Ref. N-12 \ TR Lydia MT244

Beckton Neptune R2 K065
 Beckton Belga K285 JL
 Beckton Lancer F134 TS
 Beckton Lydia E251 CL
 Bfck Cherokee Cnyn 4912
 TR Dyna LT111

TR Ricardo RT574
TR WILLOW TT712
 \ Buckeye Wilma K69

Buf Crk Dynamics 3820
 Buckeye Ida

DAM		Calv.Ease	BW	WW	YW	Milk	HPG	Stay	Maint.En.
Age	2	12	-2.2	31	52	13	10	15	-6.2
Wt	965								
Prog.BW	73								
WR	98								
YR	95								
Cow Eff.	NA	Marb +.06	REA +.06	Bfat +.00		BWt 73	WR 98	YR 95	Fr.

★★★★★ for Low Maintenance, Calving Ease, Stayability.

335 **TR CEDAR WT921**
 1-A 100% # 1324453 Tattoo: TR2A9 WT92
 Birth: 2-19-09

Beckton Epic K F075
TR EPIC ST618
 Ref. E-7 \ Beckton Kit F468 JL

Beckton Epic D404
 Beckton Belga D483 KR
 Beckton Julian GG B571
 Beckton Kit A517 NP
 Beckton Julian GG B571
 Ms Geometric 917

TR Julian LT151
TR CEDAR RT514
 \ Ms Geometric 004

Leachman Heavenly 8141
 Ms Geometric 810

DAM		Calv.Ease	BW	WW	YW	Milk	HPG	Stay	Maint.En.
Age	4	13	-2.7	25	48	12	12	14	1.6
Wt	1510								
Prog.BW	62								
WR	92								
YR	93								
Cow Eff.	NA	Marb +.07	REA +.18	Bfat +.01		BWt 70	WR 93	YR 95	Fr.

★★★★★ for Low Maintenance, Rib-eye area, Calving Ease, Stayability.

333 **TR DYNA WT908**
 1-A 100% # 1324431 Tattoo: TR2A9 WT90
 Birth: 3-17-09

Bfck Cherokee Cnyn 4912
TR RICARDO RT574
 Ref. B-2 \ TR Dyna LT111

Beckton Lancer F134 TS
TR DYNA LT118
 \ TR Dyna HT824

Buf Crk Chf 824-1658
 MRM 1431 8611 9109
 Beckton Julian GG B571
 BSF Dyna JT976
 Beckton Lancer TS D390
 Beckton Tara D565 CB
 Buf Crk Dynamics 3820
 Buf Crk Dyna 3082

DAM		Calv.Ease	BW	WW	YW	Milk	HPG	Stay	Maint.En.
Age	8	14	-5.1	27	46	16	9	15	-7.1
Wt	1275								
Prog.BW	78								
WR	101								
YR	101								
Cow Eff.	NA	Marb +.13	REA +.15	Bfat -.01		BWt 63	WR 109	YR 100	Fr.

★★★★★ for Low Maintenance, Marbling, Rib-eye area, Calving Ease, Stayability.



• Heifers •

336 **TR CEDAR WT917**
 1-A 100% # 1324447 Tattoo: TR2A9 WT91
 Birth: 2-22-09

Beckton Julian GG B571
 BKT Julian 7526 G
 BKT Marta 9A13 JL

TR JULIAN LT151
 Ref. J-10
 Ms Geometric 917
 BJR Yo 121
 Ms Geometric

Beckton Lancer T A664
 Beckton Lancer 9380
 Beckton Coca 9119 TJ

TR CEDAR PT466
 Ms Geometric 917
 BJR Yo 121
 Ms Geometric

DAM		Calv.Ease	BW	WW	YW	Milk	HPG	Stay	Maint.En.
Age	5	13	-3.4	27	54	10	11	15	14.8
Wt	1635	Marb	+0.27	REA	+0.07	Bfat	+0.00	BWt	71
Prog.BW	77	WR	99	YR	101	Fr.	93		
WR	99								
YR	101								
Cow Eff.	NA								



337 **TR RUTH WT920**
 1-A 100% # 1324451 Tattoo: TR2A9 WT92
 Birth: 2-28-09

Beckton Julian GG B571
 BKT Julian 7526 G
 BKT Marta 9A13 JL

TR JULIAN ST630
 Ref. J-11
 Ms Geometric 003
 BJR Make My Day 981
 Ms Geometric 277

TR Julian LT151
 Beckton Julian GG B571
 Ms Geometric 917

TR RUTH RT500
 Beckton Ruth C176 RN
 Beckton Ranger 7003
 Beckton Ruth 9815 JL

DAM		Calv.Ease	BW	WW	YW	Milk	HPG	Stay	Maint.En.
Age	4	13	-2.0	26	49	10	12	14	4.2
Wt	1445	Marb	+0.16	REA	+0.14	Bfat	+0.01	BWt	74
Prog.BW	75	WR	97	YR	96	Fr.	94		
WR	97								
YR	96								
Cow Eff.	NA								

★★★★★ for Marbling, Rib-eye area, Calving Ease, Stayability.

339 **TR RUTH WT924**
 1-A 100% # 1324458 Tattoo: TR2A9 WT92
 Birth: 3-6-09

Bfck Cherokee Cnyn 4912
 Buf Crk Chf 824-1658
 MRM 1431 8611 9109

TR RICARDO RT574
 Ref. B-2
 TR Dyna LT111
 Beckton Julian GG B571
 BSF Dyna JT976

Mushrush LT N020
 TR Julian LT142
 Mushrush Lana 1061

TR RUTH RT534
 TR Ruth LT126
 BSF Julian JT911
 Beckton Ruth D817 NP

DAM		Calv.Ease	BW	WW	YW	Milk	HPG	Stay	Maint.En.
Age	4	16	-4.6	23	44	12	10	16	-7.6
Wt	1215	Marb	+0.09	REA	+0.32	Bfat	-0.01	BWt	64
Prog.BW	73	WR	91	YR	93	Fr.	92		
WR	91								
YR	93								
Cow Eff.	NA								

★★★★★ for Low Maintenance, Rib-eye area, Calving Ease, Stayability.

338 **TR CEDAR WT918**
 1-A 100% # 1324449 Tattoo: TR2A9 WT91
 Birth: 2-16-09

Bfck Cherokee Cnyn 4912
 Buf Crk Chf 824-1658
 MRM 1431 8611 9109

TR RICARDO RT574
 Ref. B-2
 TR Dyna LT111
 Beckton Julian GG B571
 BSF Dyna JT976

TR Julian LT151
 Beckton Julian GG B571
 Ms Geometric 917

TR CEDAR PT493
 TR Cedar MT245
 Beckton Lancer F134 TS
 Ms Geometric 004

DAM		Calv.Ease	BW	WW	YW	Milk	HPG	Stay	Maint.En.
Age	5	17	-6.1	23	42	13	11	15	-4.0
Wt	1350	Marb	+0.15	REA	+0.31	Bfat	+0.00	BWt	59
Prog.BW	63	WR	93	YR	94	Fr.	87		
WR	93								
YR	94								
Cow Eff.	NA								

★★★★★ for Low Maintenance, Marbling, Rib-eye area, Calving Ease, Stayability.

340 **TR WILLOW WT922**
 1-A 100% # 1324455 Tattoo: TR2A9 WT92
 Birth: 3-6-09

Bfck Cherokee Cnyn 4912
 Buf Crk Chf 824-1658
 MRM 1431 8611 9109

TR RICARDO RT574
 Ref. B-2
 TR Dyna LT111
 Beckton Julian GG B571
 BSF Dyna JT976

Beckton Cody V E023
 Beckton Cody C401
 Beckton Birdie C353 VG

TR WILLOW RT519
 Buckeye Yvonne K97
 Dmw Mmday H17
 Buckeye Pearl

DAM		Calv.Ease	BW	WW	YW	Milk	HPG	Stay	Maint.En.
Age	4	14	-5.0	20	40	14	12	12	1.5
Wt	1515	Marb	+0.13	REA	+0.27	Bfat	+0.00	BWt	62
Prog.BW	70	WR	93	YR	97	Fr.	90		
WR	93								
YR	97								
Cow Eff.	NA								

★★★★★ for Low Maintenance, Marbling, Rib-eye area, Calving Ease.

Reference Sires

The goal for Beckton's program has always been to develop breeding seedstock which offer increased levels of performance for the commercial cattleman. Increased performance does not mean maximizing weight and size, which have already reached the upper limit of economic

value for the packer and consumer. It does, however, mean increasing performance related to calving percentage and weaning percentage; and increasing performance related to cow maintenance requirements and "pounds of calf per acre" efficiency.



Beckton Julian B571 (Ref. Sire J-1)

• Reference Sires •

B-1 **BKT CLIFFTOP TP R288**
1-A 100% # 1042026 Tattoo: WF5 R288

Birth: 3-14-05
 ✓ BJR Topper 5241
BECKTON CLIFFTOP T C075
 Ref. B
 \ Beckton Barmaid A761 TR
 ✓ Bieber Topper 2476
 \ BJR Lakina 002-0142
 ✓ Beckton Tartan 8148
 \ Bkt Barmaid 8925 KR
 ✓ Beckton Copper J E616
 \ Beckton Ruth E549 TP
BECKTON CHRISTY K209 CO
 \ Beckton Christy A111 VQ
 \ Bkt Christy 9A01 CL

DAM		Calv.Ease	BW	WW	YW	Milk	HPG	Stay	Maint.En.
Age	5	12	-4.4	20	47	17	7	14	-4.3
Wt	1065	(.49)	(.76)	(.68)	(.63)	(.49)	(.12)	(.20)	(.33)
Wean Pct.	56%	Marb +.01 (.44)		REA +.28 (.40)		Bfat +.00 (.25)			
Cow Eff.	117	BWt	WWt	WR	ADG	YWt	YR	Scr.	Fr.
		73	594	107	4	1163	107	38	5.0

★★★★★ for Low Maintenance, Gainability, Rib-eye area, High Cow Efficiency, Calving Ease, Stayability.

C-2 **BECKTON ACTION T061 D1**
1-A 100% # 1178356 Tattoo: BKT7 T061

Birth: 2-19-07
 ✓ Beckton Cody KH M390
BECKTON CODY K2 R168
 Ref. C
 \ Beckton Tamara K249 VG
 ✓ Beckton Cody K G701
 \ Beckton Tamara J124 HR
 ✓ Beckton Vegas SV H078
 \ Beckton Tamara HA38 WR
 ✓ Beckton Dominor Z E401
 \ Beckton Barmaid J012 CO
BECKTON BELGA R716 DM
 \ Beckton Belga K285 JL
 \ Beckton Julian GG B571
 \ Beckton Belga G493 HR

DAM		Calv.Ease	BW	WW	YW	Milk	HPG	Stay	Maint.En.
Age	2	15	-4.5	32	77	19	12	15	-2.1
Wt	880	(.26)	(.53)	(.44)	(.39)	(.26)	(.01)	(.01)	(.01)
Wean Pct.	57%	Marb +.01 (.26)		REA +.40 (.25)		Bfat +.01 (.20)			
Cow Eff.	119	BWt	WWt	WR	ADG	YWt	YR	Scr.	Fr.
		62	572	110	4	1199	114	32	5.0

★★★★★ for Low Maintenance, Growth, Gainability, Rib-eye area, High Cow Efficiency, Calving Ease, Stayability.

B-2 **TR RICARDO RT574**
1-A 100% # 1045620 Tattoo: TR2A5 RT5

Birth: 2-21-05
 ✓ Buf Crk Chf 824-1658
BFCK CHEROKEE CNYN 4912
 Ref. B
 \ MRM 1431 8611 9109
 ✓ Beckton Julian GG B571
TR DYNA LT111
 \ BSF Dyna JT976
 ✓ Buf Crk Chief092-824
 \ Bflo Crk Carie VC473
 ✓ Buf Crk Cherokee1431
 \ MRM 8454 8219 8611
 ✓ BKT Julian 7526 G
 \ BKT Marta 9A13 JL
 ✓ TR Lancer G010
 \ Buf Crk Dyna 3082

DAM		Calv.Ease	BW	WW	YW	Milk	HPG	Stay	Maint.En.
Age	4	15	-4.7	31	57	16	11	17	-8.3
Wt	NA	(.34)	(.76)	(.63)	(.58)	(.33)	(.22)	(.21)	(.23)
Wean Pct.	NA%	Marb +.16 (.47)		REA +.55 (.44)		Bfat +.00 (.31)			
Cow Eff.	NA	BWt	WWt	WR	ADG	YWt	YR	Scr.	Fr.
		69	647	101	3	1186	102	36	5.0

★★★★★ for Low Maintenance, Marbling, Rib-eye area, Calving Ease, Stayability.



TR Ricardo RT574

C-1 **BECKTON CODY K1 P014**
1-A 100% # 978340 Tattoo: WF4 P014

Birth: 2-14-04
 ✓ Beckton Cody K G701
BECKTON CODY KH M390
 Ref. C
 \ Beckton Tamara J124 HR
 ✓ Beckton Warrior T C371
BECKTON ROSE M126 WR
 \ Beckton Rose D741 LN
 ✓ Beckton Cody C401
 \ Beckton Christy B007 KR
 ✓ Beckton Herald F FA20
 \ Beckton Tamara F183 CT
 ✓ JKG Chiefton L303
 \ Beckton Tamla A671 TR
 ✓ Beckton Lancer T A664
 \ Beckton Rose A624 BF

DAM		Calv.Ease	BW	WW	YW	Milk	HPG	Stay	Maint.En.
Age	2	15	-5.6	17	53	20	7	10	6.3
Wt	915	(.47)	(.74)	(.66)	(.62)	(.48)	(.16)	(.01)	(.34)
Wean Pct.	55%	Marb -.07 (.39)		REA +.08 (.36)		Bfat -.01 (.22)			
Cow Eff.	116	BWt	WWt	WR	ADG	YWt	YR	Scr.	Fr.
		62	581	108	4	1170	119	33	5.0

★★★★★ for Gainability, High Cow Efficiency, Calving Ease.

D-1 **BECKTON DOMINOR Z1 R610**
1-A 100% # 1042348 Tattoo: WF5 R610

Birth: 4-3-05
 ✓ Beckton Dominor Z E401
BECKTON DOMINOR ZC M919
 Ref. D
 \ Beckton Barmaid J012 CO
 ✓ Beckton Loki F251
BECKTON SIERRA K557 LO
 \ Beckton Sierra C157 CL
 ✓ Beckton Dominor 9455
 \ Beckton Belga B061 ZN
 ✓ Beckton Copper JT G095
 \ Beckton Barmaid G565 LN
 ✓ Beckton Lancer TZ D525
 \ Bkt Pine Marie D126 JL
 ✓ Beckton Clipper JL A095
 \ Beckton Sierra A086 CL

DAM		Calv.Ease	BW	WW	YW	Milk	HPG	Stay	Maint.En.
Age	5	15	-5.5	29	67	24	6	16	-0.3
Wt	1100	(.43)	(.69)	(.61)	(.55)	(.43)	(.01)	(.01)	(.32)
Wean Pct.	55%	Marb +.16 (.38)		REA +.19 (.35)		Bfat +.01 (.22)			
Cow Eff.	115	BWt	WWt	WR	ADG	YWt	YR	Scr.	Fr.
		69	600	102	5	1169	105	34	5.5

★★★★★ for Low Maintenance, Gainability, Marbling, Rib-eye area, Calving Ease, Stayability.

• Reference Sires •

E-1 **BECKTON EPIC K4 N795**
1-A 100% # 916917 Tattoo: WF3 N795

Birth: 4-21-03
 Beckton Epic K F075
BECKTON EPIC KJ J722
 Ref. E Beckton Lana F891 JL
 Beckton Epic D404
BECKTON SIERRA J789 EP
 Beckton Sierra C157 CL
 Beckton Epic D404
 Beckton Belga D483 KR
 Beckton Clifftop T C075
 Beckton Lana 9610 TP
 Beckton Saga KJ B702
 Beckton Kuruba B508 PC
 Beckton Clipper JL A095
 Beckton Sierra A086 CL

Calv.Ease	BW	WW	YW	Milk	HPG	Stay	Maint.En.
7	-0.6	35	88	11	2	12	4.6
(.71)	(.82)	(.78)	(.77)	(.71)	(.40)	(.20)	(.49)
Marb +0.27 (.48)		REA +0.16 (.44)		Bfat +0.01 (.26)			
BWt	WWt	WR	ADG	YWt	YR	Scr.	Fr.
85	619	106	4	1191	112	36	6.5

DAM	
Age	4
Wt	1095
Wean Pct.	54%
Cow Eff.	113

★★★★★ for Growth, Gainability, Marbling, Rib-eye area, Calving Ease.



Beckton Epic K4 N795

E-2 **BECKTON EPIC R350 K**
1-A 100% # 1042088 Tattoo: BKT5 R350

Birth: 3-17-05
 Beckton Epic D404
BECKTON EPIC K F075
 Ref. E Beckton Belga D483 KR
 Beckton Epic D404
 Beckton Kuruba B508 PC
 Beckton Kaiser FD 9253
 Beckton Belga A036 MB
 Beckton CODY C401
BECKTON LARKABA E042 CD
 Beckton Larkaba C317 CL
 Beckton Epic D404
 Beckton Kuruba B508 PC
 Beckton Kaiser FD 9253
 Beckton Belga A036 MB
 Beckton Clipper JL A095
 Beckton Scarlet A742 RB
 Beckton Clipper J 9956
 Bkt Larkaba 7596 PN

Calv.Ease	BW	WW	YW	Milk	HPG	Stay	Maint.En.
11	-3.7	25	54	17	11	11	1.0
(.23)	(.26)	(.25)	(.25)	(.25)	(.19)	(.17)	(.18)
Marb +0.14 (.01)		REA +0.09 (.01)		Bfat +0.01 (.01)			
BWt	WWt	WR	ADG	YWt	YR	Scr.	Fr.
95	696	108	4	1280	112	38	6.5

DAM	
Age	10
Wt	NA
Wean Pct.	NA%
Cow Eff.	NA

★★★★★ for Low Maintenance, Gainability, Marbling, Calving Ease.

E-4 **BECKTON EMCEE S466**
1-A 100% # 1118929 Tattoo: BKT6 S466

Birth: 3-20-06
 Beckton Epic KJ J722
BECKTON EPIC K4 N795
 Ref. E-1 Beckton Sierra J789 EP
 Beckton Epic K F075
 Beckton Lana F891 JL
 Beckton Epic D404
 Beckton Sierra C157 CL
 JKG Chiefton L303
 Beckton Tamla A671 TR
BECKTON LARKABA H798 WR
 Beckton Larkaba E042 CD
 Beckton Epic K F075
 Beckton Lana F891 JL
 Beckton Epic D404
 Beckton Sierra C157 CL
 Beckton Warrior T C371
 Beckton Larkaba E042 CD
 Beckton CODY C401
 Beckton Larkaba C317 CL

Calv.Ease	BW	WW	YW	Milk	HPG	Stay	Maint.En.
12	-3.6	26	60	15	5	11	3.2
(.32)	(.66)	(.56)	(.51)	(.31)	(.16)	(.10)	(.16)
Marb +0.18 (.39)		REA +0.12 (.36)		Bfat +0.00 (.23)			
BWt	WWt	WR	ADG	YWt	YR	Scr.	Fr.
73	621	105	4	1213	104	37	6.5

DAM	
Age	8
Wt	1175
Wean Pct.	53%
Cow Eff.	111

★★★★★ for Low Maintenance, Marbling, Calving Ease.

E-3 **BECKTON EPITOMY S250**
1-A 100% # 1118713 Tattoo: WF6 S250

Birth: 3-8-06
 Beckton Epic KJ J722
BECKTON EPIC K4 N795
 Ref. E-1 Beckton Sierra J789 EP
 Beckton Epic D404
 Beckton Lana F891 JL
 Beckton Epic D404
 Beckton Sierra C157 CL
 Beckton Julian GG B571
BECKTON TARA M635 JL
 Beckton Tara J266 HR
 Beckton Epic K F075
 Beckton Lana F891 JL
 Beckton Epic D404
 Beckton Sierra C157 CL
 Beckton Julian 7526G
 Bkt Marta 9A13 JL
 Beckton Herald F FA20
 Beckton Tara F633 NM

Calv.Ease	BW	WW	YW	Milk	HPG	Stay	Maint.En.
13	-2.5	22	62	13	8	16	1.0
(.32)	(.70)	(.59)	(.51)	(.31)	(.16)	(.01)	(.16)
Marb +0.17 (.35)		REA +0.19 (.33)		Bfat +0.02 (.24)			
BWt	WWt	WR	ADG	YWt	YR	Scr.	Fr.
74	693	118	4	1316	113	36	5.5

DAM	
Age	4
Wt	1020
Wean Pct.	65%
Cow Eff.	136

★★★★★ for Low Maintenance, Growth, Gainability, Marbling, Rib-eye area, High Cow Efficiency, Calving Ease, Stayability.

E-5 **BECKTON EPIC K6 S569**
1-A 100% # 1119032 Tattoo: WF6 S569

Birth: 3-24-06
 Beckton Epic K F075
BECKTON EPIC KM M115
 Ref. E Beckton Minerva F495 CH
 Beckton Epic D404
 Beckton Belga D483 KR
 Beckton Champ R A583
 Beckton Minerva CB69 JL
 Beckton Lancer T4 J536
 Beckton Sierra J659 DM
BECKTON SIERRA N703 LM
 Beckton Sierra L887 LN
 Beckton Epic D404
 Beckton Belga D483 KR
 Beckton Champ R A583
 Beckton Minerva CB69 JL
 Beckton Lancer T4 J536
 Beckton Sierra J659 DM
 Beckton Lancer TZ D525
 Beckton Sierra H442 HD

Calv.Ease	BW	WW	YW	Milk	HPG	Stay	Maint.En.
7	-0.4	41	88	22	9	16	0.1
(.31)	(.67)	(.55)	(.51)	(.30)	(.16)	(.01)	(.15)
Marb +0.15 (.40)		REA +0.07 (.36)		Bfat +0.01 (.22)			
BWt	WWt	WR	ADG	YWt	YR	Scr.	Fr.
78	698	117	5	1342	119	37	6.0

DAM	
Age	3
Wt	980
Wean Pct.	65%
Cow Eff.	136

★★★★★ for Low Maintenance, Growth, Gainability, Marbling, High Cow Efficiency, Calving Ease, Stayability.

• Reference Sires •

E-6 BECKTON EMPEROR T641 E2
1-A 100% # 1178933 Tattoo: BKT7 T641

Birth: 3-31-07
 Beckton Epic K4 N795
BECKTON EMPEROR R100
 Ref. E Beckton Tamara N180 JO
 Beckton Epic KJ J722
 Beckton Sierra J789 EP
 Beckton Julio L233
 Beckton Tamara L132 CT
 Beckton Epic K3 M606
BECKTON VERNICE R416 EP
 Beckton Vernice K482 HD
 Beckton Epic KJ J722
 Beckton Lana F268 CT
 Beckton Hadrian F C486
 Beckton Vernice F513 CL

DAM		Calv.Ease	BW	WW	YW	Milk	HPG	Stay	Maint.En.
Age	2	9	-1.6	31	66	16	6	15	1.7
Wt	930	(.26)	(.57)	(.47)	(.40)	(.26)	(.01)	(.01)	(.01)
Wean Pct.	57%	Marb	+.12 (.26)		REA	+.23 (.25)		Bfat	+.00 (.20)
Cow Eff.	120	BWt	WWt	WR	ADG	YWt	YR	Scr.	Fr.
		69	611	110	4	1173	110	34	5.5

★★★★★ for Low Maintenance, Growth, Gainability, Marbling, Rib-eye area, High Cow Efficiency, Calving Ease, Stayability.

H-2 BECKTON HASTEN H S462
1-A 100% # 1118925 Tattoo: BKT6 S462

Birth: 3-19-06
 Beckton Hustler C2 L079
BECKTON HASTEN P292
 Ref. H Beckton Sheba L644 CH
 Beckton Hustler CN J102
 Beckton Barmaid J012 CO
 Beckton Champ R3 H338
 Beckton Sheba CB73 JL
 Beckton Hadrian F C486
 Bkt Pine Marie C046 CH
BECKTON LAKME G128 HD
 Beckton Lakme E373 CL
 Beckton Clipper KT C624
 Beckton Lakme C030 HB

DAM		Calv.Ease	BW	WW	YW	Milk	HPG	Stay	Maint.En.
Age	9	14	-5.6	32	60	21	10	11	2.8
Wt	1100	(.31)	(.68)	(.57)	(.50)	(.30)	(.14)	(.11)	(.13)
Wean Pct.	62%	Marb	-.01 (.36)		REA	+.11 (.33)		Bfat	-.01 (.20)
Cow Eff.	129	BWt	WWt	WR	ADG	YWt	YR	Scr.	Fr.
		76	676	115	4	1200	108	36	5.5

★★★★★ for Low Maintenance, Gainability, High Cow Efficiency, Calving Ease.

E-7 TR EPIC ST618
1-A 100% # 1122033 Tattoo: TR2A6 ST6

Birth: 2-26-06
 Beckton Epic D404
BECKTON EPIC K F075
 Ref. E Beckton Belga D483 KR
 Beckton Saga KJ B702
 Beckton Kuruba B508 PC
 Beckton Kaiser FD 9253
 Beckton Belga A036 MB
 Beckton Julian GG B571
BECKTON KIT F468 JL
 Beckton Kit A517 NP
 Beckton Julian 7526G
 Bkt Marta 9A13 JL
 Bkt Neptune 8460 R
 BchRch Kit935 35L416

DAM		Calv.Ease	BW	WW	YW	Milk	HPG	Stay	Maint.En.
Age	NA	10	-1.5	29	52	14	11	15	-6.8
Wt	NA	(.35)	(.71)	(.63)	(.52)	(.32)	(.22)	(.27)	(.18)
Wean Pct.	NA	Marb	+.05 (.38)		REA	+.33 (.36)		Bfat	+.02 (.26)
Cow Eff.	NA	BWt	WWt	WR	ADG	YWt	YR	Scr.	Fr.
		92	647	NA	5	1323	NA	43	6.0

★★★★★ for Low Maintenance, Gainability, Rib-eye area, Calving Ease, Stayability.

H-3 BECKTON HERITAGE T270 J2
1-A 100% # 1178780 Tattoo: WF7 T270

Birth: 3-12-07
 Beckton Hustler C2 L079
BECKTON HERITAGE N013
 Ref. H Beckton Lana L007 JL
 Beckton Hustler CN J102
 Beckton Barmaid J012 CO
 Beckton Julian G1 J526
 Beckton Lana J790 EP
 Beckton Julian 7526G
 Bkt Marta 9A13 JL
BECKTON COCA P602 JL
 Beckton Coca J270 CD
 Beckton Cody K G701
 Beckton Coca G809 WR

DAM		Calv.Ease	BW	WW	YW	Milk	HPG	Stay	Maint.En.
Age	3	15	-3.4	37	65	15	10	17	-2.6
Wt	1005	(.29)	(.59)	(.49)	(.43)	(.29)	(.01)	(.01)	(.12)
Wean Pct.	60%	Marb	+.17 (.30)		REA	+.15 (.29)		Bfat	+.00 (.25)
Cow Eff.	126	BWt	WWt	WR	ADG	YWt	YR	Scr.	Fr.
		70	662	113	4	1186	107	38	5.5

★★★★★ for Low Maintenance, Growth, Gainability, Marbling, Rib-eye area, High Cow Efficiency, Calving Ease, Stayability.

H-1 BECKTON HALFMANNHUSTLER R588
1-A 100% # 1042326 Tattoo: BKT5 R588

Birth: 4-1-05
 Beckton Hustler C G407
BECKTON HUSTLER CN J102
 Ref. H Beckton Belga G355 NP
 LCC Heaven or Bust 1000B
 Beckton Rose E032 CL
 Beckton Neptune RR B284
 Beckton Belga B061 ZN
 Beckton Clipper J 9956
 Beckton Mona 9766 MJ
BECKTON VERNICE F513 CL
 Beckton Vernice A663 PC
 Beckton Pacer 8940
 Bkt Vernice 8994 NM

DAM		Calv.Ease	BW	WW	YW	Milk	HPG	Stay	Maint.En.
Age	10	12	-4.5	32	67	11	7	11	5.0
Wt	1305	(.21)	(.36)	(.28)	(.29)	(.23)	(.16)	(.01)	(.16)
Wean Pct.	48%	Marb	-.11 (.30)		REA	-.04 (.28)		Bfat	-.02 (.22)
Cow Eff.	100	BWt	WWt	WR	ADG	YWt	YR	Scr.	Fr.
		67	620	103	5	1222	111	36	6.0

★★★★★ for Growth, Gainability, Calving Ease.



Beckton HalfmannHustler R588

• Reference Sires •

J-1 BECKTON JULIAN GG B571
1-A 100% # 387580 Tattoo: WF2 B571

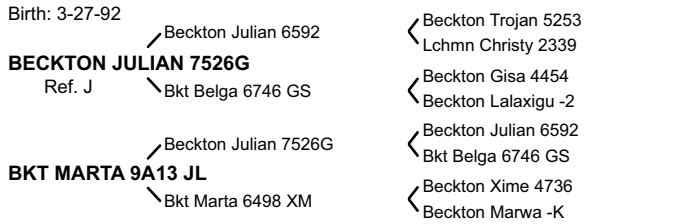

Calv.Ease	BW	WW	YW	Milk	HPG	Stay	Maint.En.
19	-5.9	29	56	15	5	24	-7.0
(.90)	(.92)	(.91)	(.91)	(.90)	(.76)	(.70)	(.62)

DAM	
Age	3
Wt	1015
Wean Pct.	56%
Cow Eff.	118

Marb	REA	Bfat
+1.0	+4.8	+0.2
(.72)	(.69)	(.58)

BWt	WWt	WR	ADG	YWt	YR	Scr.	Fr.
65	627	113	3	1140	112	NA	5.0

★★★★★ for Low Maintenance, Rib-eye area, High Cow Efficiency, Calving Ease, Stayability.

J-4 BECKTON JUSTICE C1 R483
1-A 100% # 1042221 Tattoo: BKT5 R483

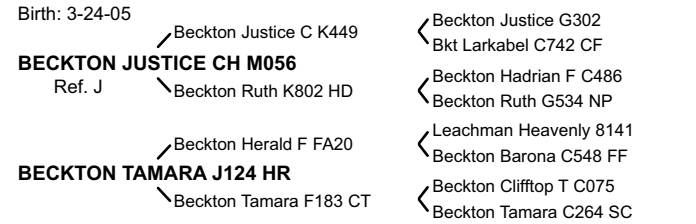

Calv.Ease	BW	WW	YW	Milk	HPG	Stay	Maint.En.
15	-4.1	26	65	17	12	12	0.5
(.49)	(.73)	(.64)	(.60)	(.49)	(.16)	(.10)	(.23)

DAM	
Age	6
Wt	1175
Wean Pct.	60%
Cow Eff.	125

Marb	REA	Bfat
+0.6	+1.0	-0.1
(.40)	(.36)	(.23)

BWt	WWt	WR	ADG	YWt	YR	Scr.	Fr.
76	700	109	4	1312	115	41	6.0

★★★★★ for Low Maintenance, Growth, Gainability, High Cow Efficiency, Calving Ease.

J-2 BECKTON JET L P491
1-A 100% # 978816 Tattoo: BKT4 P491

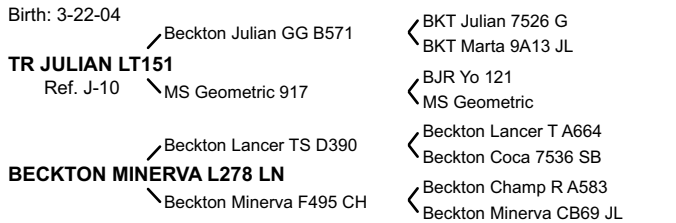

Calv.Ease	BW	WW	YW	Milk	HPG	Stay	Maint.En.
19	-8.1	14	34	19	11	15	2.0
(.57)	(.76)	(.69)	(.67)	(.58)	(.10)	(.25)	(.43)

DAM	
Age	3
Wt	1055
Wean Pct.	52%
Cow Eff.	109

Marb	REA	Bfat
+1.9	+1.5	+0.0
(.44)	(.40)	(.24)

BWt	WWt	WR	ADG	YWt	YR	Scr.	Fr.
60	601	103	3	1067	104	38	4.0

★★★★★ for Low Maintenance, Marbling, Rib-eye area, Calving Ease, Stayability.

J-5 BECKTON JULIAN G5 S107
1-A 100% # 1118570 Tattoo: WF6 S107

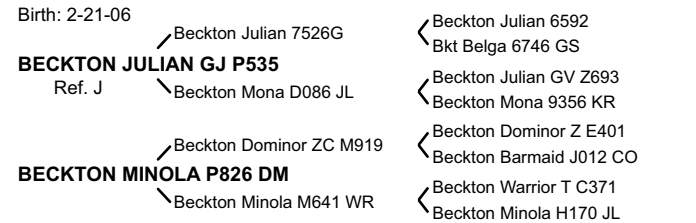

Calv.Ease	BW	WW	YW	Milk	HPG	Stay	Maint.En.
9	0.4	41	84	10	12	18	1.6
(.29)	(.70)	(.56)	(.49)	(.28)	(.01)	(.01)	(.01)

DAM	
Age	2
Wt	1010
Wean Pct.	55%
Cow Eff.	116

Marb	REA	Bfat
+1.9	+1.3	+0.0
(.38)	(.35)	(.23)

BWt	WWt	WR	ADG	YWt	YR	Scr.	Fr.
74	640	115	4	1237	113	43	4.5

★★★★★ for Low Maintenance, Growth, Gainability, Marbling, Rib-eye area, High Cow Efficiency, Calving Ease, Stayability.

J-3 BECKTON JULIAN G3 P608
1-A 100% # 978932 Tattoo: WF4 P608

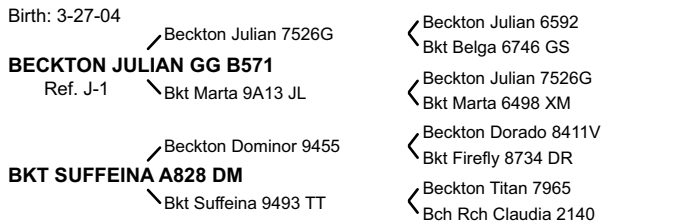

Calv.Ease	BW	WW	YW	Milk	HPG	Stay	Maint.En.
20	-7.4	12	41	13	12	17	-7.1
(.66)	(.80)	(.75)	(.73)	(.66)	(.24)	(.30)	(.47)

DAM	
Age	13
Wt	NA
Wean Pct.	NA%
Cow Eff.	NA

Marb	REA	Bfat
+1.9	+0.7	+0.1
(.51)	(.48)	(.35)

BWt	WWt	WR	ADG	YWt	YR	Scr.	Fr.
72	627	106	4	1159	111	35	5.0

★★★★★ for Low Maintenance, Marbling, Calving Ease, Stayability.

J-6 BECKTON ROMAN J S158
1-A 100% # 1118621 Tattoo: BKT6 S158

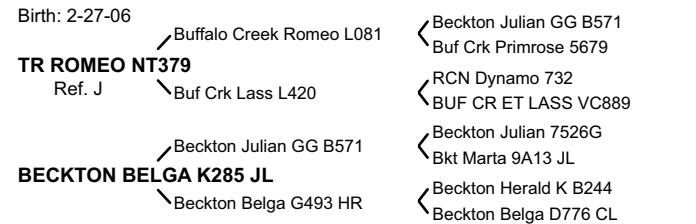

Calv.Ease	BW	WW	YW	Milk	HPG	Stay	Maint.En.
8	2.4	47	79	18	11	15	-1.0
(.32)	(.68)	(.58)	(.52)	(.30)	(.16)	(.01)	(.16)

DAM	
Age	6
Wt	1150
Wean Pct.	57%
Cow Eff.	121

Marb	REA	Bfat
-0.1	+4.5	+0.1
(.38)	(.36)	(.25)

BWt	WWt	WR	ADG	YWt	YR	Scr.	Fr.
79	660	113	4	1209	104	37	6.0

★★★★★ for Low Maintenance, Rib-eye area, High Cow Efficiency, Calving Ease, Stayability.

• Reference Sires •

J-7 **BECKTON JUSTICE T124 C1**
1-A 100% # 1178635 Tattoo: WF7 T124

Birth: 2-28-07
 Beckton Justice CH M056
BECKTON JUSTICE C1 R483
 Ref. J-4
 Beckton Tamara J124 HR
 Beckton Justice C K449
 Beckton Ruth K802 HD
 Beckton Herald F FA20
 Beckton Tamara F183 CT
 Beckton Neptune R2 K065
 Beckton Belga K285 JL
 Andras Sleep Easy 802
 COF Scarlett
BECKTON SCARLETT R808 NB
 Beckton Nebula M045
 Andras Scarlett 2029

Calv.Ease	BW	WW	YW	Milk	HPG	Stay	Maint.En.
14	-3.7	31	67	13	10	12	-5.5
(.13)	(.34)	(.24)	(.24)	(.14)	(.01)	(.01)	(.01)

DAM	
Age	2
Wt	790
Wean Pct.	63%
Cow Eff.	134

Marb	REA	Bfat
+.17	+.16	+.00
(.25)	(.24)	(.20)

BWt	WWt	WR	ADG	YWt	YR	Scr.	Fr.
61	576	111	4	1168	112	39	5.0

★★★★★ for Low Maintenance, Growth, Gainability, Marbling, Rib-eye area, High Cow Efficiency, Calving Ease.

J-10 **TR JULIAN LT151**
1-A 100% # 785157 Tattoo: TR2A1 LT1

Birth: 2-16-01
 BKT Julian 7526 G
BECKTON JULIAN GG B571
 Ref. J-1
 BKT Marta 9A13 JL
 Beckton Julian 6592
 BKT Belga 6746 GS
 BKT Julian 7526 G
 BKT Marta 6498 XM
 BJR Yogo 002-104
 BJR Cherabel830-8319
 Lchmn No Equal 1174D
 MS Geometric 363
MS GEOMETRIC 917
 BJR Yo 121
 MS Geometric

Calv.Ease	BW	WW	YW	Milk	HPG	Stay	Maint.En.
15	-3.9	30	62	10	14	14	9.2
(.72)	(.80)	(.78)	(.77)	(.73)	(.51)	(.38)	(.52)

DAM	
Age	2
Wt	NA
Wean Pct.	NA%
Cow Eff.	NA

Marb	REA	Bfat
+.30	+.23	+.01
(.53)	(.49)	(.33)

BWt	WWt	WR	ADG	YWt	YR	Scr.	Fr.
79	739	114	3	1148	106	36	5.5

★★★★★ for Growth, Marbling, Rib-eye area, Calving Ease, Stayability.

J-8 **BECKTON JULIO T863 H2**
1-A 100% # 1179154 Tattoo: BKT7 T863

Birth: 5-18-07
 Beckton Julian G1 J526
BECKTON JULIO L233
 Ref. J
 Beckton Rose J725 EP
 Beckton Julian GG B571
 Beckton Annie F743 LN
 Beckton Epic K F075
 Beckton Rose F192 CL
 Beckton Hustler C G407
 Beckton Belga G355 NP
 Beckton Julian SJ A470
 Beckton Vernice A140 JU
BECKTON VERNICE N598 HU
 Beckton Hustler CN J102
 Beckton Vernice C047 JL

Calv.Ease	BW	WW	YW	Milk	HPG	Stay	Maint.En.
13	-4.2	27	56	13	11	13	-4.0
(.20)	(.24)	(.23)	(.22)	(.21)	(.01)	(.01)	(.15)

DAM	
Age	4
Wt	1115
Wean Pct.	59%
Cow Eff.	125

Marb	REA	Bfat
-.01	+.06	+.00
(.01)	(.01)	(.01)

BWt	WWt	WR	ADG	YWt	YR	Scr.	Fr.
NA	696	116	4	1254	112	35	5.5

★★★★★ for Low Maintenance, Gainability, High Cow Efficiency, Calving Ease, Stayability.



Tongue River Julian ST630

J-9 **TR JULIAN LT142**
1-A 100% # 785183 Tattoo: TR2A1 LT1

Birth: 2-21-01
 BKT Julian 7526 G
BECKTON JULIAN GG B571
 Ref. J-1
 BKT Marta 9A13 JL
 Beckton Cody V E023
 Beckton Lana E828 SC
TR LANA G760
 Beckton Julian 6592
 BKT Belga 6746 GS
 BKT Julian 7526 G
 BKT Marta 6498 XM
 Beckton Cody C401
 Beckton Birdie C353 VG
 Beckton Scamp 8954
 Beckton Lana B695 SG

Calv.Ease	BW	WW	YW	Milk	HPG	Stay	Maint.En.
24	-6.0	33	61	20	18	14	-6.8
(.81)	(.88)	(.86)	(.85)	(.81)	(.68)	(.32)	(.58)

DAM	
Age	4
Wt	NA
Wean Pct.	NA%
Cow Eff.	NA

Marb	REA	Bfat
+.06	+.04	-.01
(.58)	(.57)	(.41)

BWt	WWt	WR	ADG	YWt	YR	Scr.	Fr.
76	782	113	3	1215	112	36	5.0

★★★★★ for Low Maintenance, Growth, Calving Ease, Stayability.

J-11 **TR JULIAN ST630**
1-A 100% # 1121975 Tattoo: TR2A6 ST6

Birth: 2-21-06
 BKT Julian 7526 G
BECKTON JULIAN GG B571
 Ref. J
 BKT Marta 9A13 JL
 BJR Make My Day 981
MS GEOMETRIC 003
 MS Geometric 277
 Beckton Julian 6592
 BKT Belga 6746 GS
 BKT Julian 7526 G
 BKT Marta 6498 XM
 BJR Easy Rider 781
 BJR Tow Kana 117-710
 BKT Julian 7526 G
 MS Geometric 962

Calv.Ease	BW	WW	YW	Milk	HPG	Stay	Maint.En.
16	-3.4	28	53	10	13	15	2.2
(.34)	(.62)	(.54)	(.48)	(.33)	(.13)	(.20)	(.16)

DAM	
Age	6
Wt	NA
Wean Pct.	NA%
Cow Eff.	NA

Marb	REA	Bfat
+.17	+.20	+.01
(.39)	(.38)	(.32)

BWt	WWt	WR	ADG	YWt	YR	Scr.	Fr.
76	690	NA	4	1303	NA	NA	6.5

★★★★★ for Low Maintenance, Marbling, Rib-eye area, Calving Ease, Stayability.

• Reference Sires •

L-1 BECKTON LANCER F442 T
1-A 100% # 533603 Tattoo: WF6 F442

Birth: 3-19-96
 Beckton Lancer 9380
BECKTON LANCER T A664
 Ref. L Beckton Coca 9119 TJ
 Beckton Trojan 5253
 Bkt Kilo Lana 4251
 Beckton Trojan 7061P
 Beckton Coca 7536 SB
 Beckton Dominor 9455
 Bkt Suffeina 8411V
BKT SUFFEINA A828 DM
 Bkt Suffeina 9493 TT
 Beckton Titan 7965
 Bch Rch Claudia 2140

Calv.Ease	BW	WW	YW	Milk	HPG	Stay	Maint.En.
11	-0.4	32	51	7	3	10	.0
(.90)	(.94)	(.93)	(.92)	(.89)	(.73)	(.27)	(.61)
Marb +0.27		(.80)	REA +0.49		(.76)	Bfat -0.03	
(.69)				(.69)			
BWt	WWt	WR	ADG	YWt	YR	Scr.	Fr.
82	623	112	3	1084	109	37	5.5

DAM

Age	5
Wt	1210
Wean Pct.	52%
Cow Eff.	108



Beckton Lancer F442 T

★★★★★ for Low Maintenance, Marbling, Rib-eye area, Calving Ease.

L-2 BECKTON LOKI CL S284
1-A 100% # 1118747 Tattoo: BKT6 S284

Birth: 3-10-06
 Beckton Loki F251
BECKTON LOKI C M740
 Ref. L BKT Larkeisa J051 CK
 Beckton Lancer TZ D525
 Bkt Pine Marie D126 JL
 Beckton Latigo G714
BECKTON LAKME J460 LT
 Beckton Lakme G128 HD
 Beckton Colt G552
 Bkt Larkeisa G448 CT
 Beckton Lancer TZ D525
 Beckton Marta Z381 CL
 Beckton Hadrian FC E166
 Beckton Lakme E373 CL

Calv.Ease	BW	WW	YW	Milk	HPG	Stay	Maint.En.
15	-5.5	26	59	17	7	13	3.4
(.32)	(.69)	(.60)	(.53)	(.31)	(.16)	(.13)	(.17)
Marb +0.08		(.36)	REA +0.05		(.33)	Bfat +0.00	
(.21)							
BWt	WWt	WR	ADG	YWt	YR	Scr.	Fr.
82	640	109	4	1198	103	39	6.0

DAM

Age	7
Wt	1160
Wean Pct.	55%
Cow Eff.	116

★★★★★ for Low Maintenance, High Cow Efficiency, Calving Ease, Stayability.

N-1 BECKTON NEBULA M045
1-A 100% # 854775 Tattoo: BKT2 M045

Birth: 2-19-02
 Beckton Neptune RR B284
BECKTON NEPTUNE R2 K065
 Ref. N Beckton Lana C735 TP
 Bkt Neptune 8460 R
 Beckton Eola 8600 RR
 RDD B Topper 1675
 Beckton Lana A714 TR
 Beckton Julian GG B571
BECKTON BELGA K285 JL
 Beckton Belga G493 HR
 Beckton Julian 7526G
 Bkt Marta 9A13 JL
 Beckton Herald K B244
 Beckton Belga D776 CL

Calv.Ease	BW	WW	YW	Milk	HPG	Stay	Maint.En.
19	-7.3	25	56	8	15	12	-9.5
(.77)	(.87)	(.84)	(.82)	(.77)	(.49)	(.22)	(.56)
Marb +0.10		(.52)	REA +0.23		(.48)	Bfat +0.01	
(.31)							
BWt	WWt	WR	ADG	YWt	YR	Scr.	Fr.
59	586	108	4	1080	106	35	5.0

DAM

Age	2
Wt	860
Wean Pct.	59%
Cow Eff.	125

★★★★★ for Low Maintenance, Rib-eye area, High Cow Efficiency, Calving Ease.

L-3 BECKTON LANCER T371 H4
1-A 100% # 1178419 Tattoo: BKT7 T371

Birth: 3-16-07
 Beckton Lancer T A664
BECKTON LANCER F442 T
 Ref. L-1 Bkt Suffeina A828 DM
 Beckton Lancer 9380
 Beckton Coca 9119 TJ
 Beckton Dominor 9455
 Bkt Suffeina 9493 TT
 Leachman Heavenly 8141
 Lchmn Mldd Hvywt2463
BECKTON COCA F276 HV
 Beckton Coca B112 CB
 Leachman Dina 7011
 Beckton Cobalt K Z100
 Beckton Coca Z075 CB

Calv.Ease	BW	WW	YW	Milk	HPG	Stay	Maint.En.
11	-1.4	33	63	14	6	14	-1.4
(.32)	(.60)	(.51)	(.45)	(.31)	(.22)	(.27)	(.19)
Marb -0.03		(.34)	REA +0.25		(.34)	Bfat -0.02	
(.32)							
BWt	WWt	WR	ADG	YWt	YR	Scr.	Fr.
89	722	126	4	1292	118	37	5.5

DAM

Age	11
Wt	1245
Wean Pct.	55%
Cow Eff.	116

★★★★★ for Low Maintenance, Growth, Gainability, Rib-eye area, High Cow Efficiency, Calving Ease, Stayability.



Beckton Nebula M045

• Reference Sires •

N-2 BECKTON NEBULA L P093
1-A 100% # 978419 Tattoo: WF4 P093

Birth: 2-28-04
 Beckton Neptune R2 K065
BECKTON NEBULA M045
 Ref. N-1 Beckton Belga K285 JL
 Beckton Neptune RR B284
 Beckton Lana C735 TP
 Beckton Julian GG B571
 Beckton Belga G493 HR
 Beckton Lancer TA K644
BECKTON MARTA M021 LN
 Beckton Tamara B570 JL
 Beckton Lancer T A664
 Beckton Lancer T A664
 Beckton Marta K254 LN
 Beckton Marta G512 LN

DAM		Calv.Ease	BW	WW	YW	Milk	HPG	Stay	Maint.En.
Age	2	13	-3.0	34	69	3	13	13	-5.2
Wt	775	(.65)	(.83)	(.77)	(.74)	(.65)	(.33)	(.01)	(.38)
Wean Pct.	63%	Marb +.11 (.46)		REA +.36 (.42)		Bfat -.01 (.25)			
Cow Eff.	132	BWt	WWt	WR	ADG	YWt	YR	Scr.	Fr.
		69	560	101	4	1067	105	35	5.5

★★★★★ for Low Maintenance, Marbling, Rib-eye area, High Cow Efficiency, Calving Ease, Stayability.



Beckton Nebula L P093

N-4 BECKTON NEBULA H R233
1-A 100% # 1041971 Tattoo: BKT5 R233

Birth: 3-11-05
 Beckton Neptune R2 K065
BECKTON NEBULA M045
 Ref. N-1 Beckton Belga K285 JL
 Beckton Neptune RR B284
 Beckton Lana C735 TP
 Beckton Julian GG B571
 Beckton Belga G493 HR
 Beckton Hadrian F C486
BECKTON COCA H132 HD
 Beckton Kuruba A444 FF
 Beckton Hadrian A100
 Beckton Javelin RN Z358
 Beckton Coca CB74 JV
 Beckton Coca 9A52 BT

DAM		Calv.Ease	BW	WW	YW	Milk	HPG	Stay	Maint.En.
Age	7	16	-5.0	24	56	11	15	12	-6.2
Wt	1190	(.43)	(.64)	(.57)	(.53)	(.43)	(.18)	(.14)	(.17)
Wean Pct.	56%	Marb +.03 (.39)		REA +.22 (.36)		Bfat +.00 (.23)			
Cow Eff.	118	BWt	WWt	WR	ADG	YWt	YR	Scr.	Fr.
		70	664	103	4	1197	105	37	5.5

★★★★★ for Low Maintenance, Gainability, Rib-eye area, High Cow Efficiency, Calving Ease.

N-5 BECKTON NEBULA J R475
1-A 100% # 1042213 Tattoo: BKT5 R475

Birth: 3-23-05
 Beckton Neptune R2 K065
BECKTON NEBULA M045
 Ref. N-1 Beckton Belga K285 JL
 Beckton Neptune RR B284
 Beckton Lana C735 TP
 Beckton Julian GG B571
 Beckton Belga G493 HR
 Beckton Justice G302
BECKTON LARKEISA M138 JC
 Bkt Larkeisa G448 CT
 Beckton Julian GG B571
 Bkt Vernice 9733 PC
 Beckton Cliffort T C075
 Bkt Larkeisa C894 JV

DAM		Calv.Ease	BW	WW	YW	Milk	HPG	Stay	Maint.En.
Age	3	17	-5.0	24	52	3	13	15	-14.7
Wt	875	(.47)	(.68)	(.60)	(.56)	(.47)	(.01)	(.01)	(.26)
Wean Pct.	62%	Marb +.09 (.36)		REA +.42 (.34)		Bfat +.00 (.23)			
Cow Eff.	130	BWt	WWt	WR	ADG	YWt	YR	Scr.	Fr.
		60	595	97	4	1142	103	36	4.5

★★★★★ for Low Maintenance, Gainability, Rib-eye area, High Cow Efficiency, Calving Ease, Stayability.

N-3 BECKTON NEBULA P P707
1-A 100% # 979031 Tattoo: BKT4 P707

Birth: 4-1-04
 Beckton Neptune R2 K065
BECKTON NEBULA M045
 Ref. N-1 Beckton Belga K285 JL
 Beckton Neptune RR B284
 Beckton Lana C735 TP
 Beckton Julian GG B571
 Beckton Belga G493 HR
 Beckton Epic K1 K863
BECKTON LANA M809 EP
 Beckton Epic KN H110
 Beckton Rose H019 SC
 Beckton Dominor ZJ H657
 Beckton Lana HA34 DM
 Beckton Lana K253 DM

DAM		Calv.Ease	BW	WW	YW	Milk	HPG	Stay	Maint.En.
Age	2	16	-5.9	34	70	16	12	13	-11.3
Wt	890	(.52)	(.68)	(.63)	(.61)	(.53)	(.18)	(.10)	(.38)
Wean Pct.	71%	Marb +.22 (.39)		REA +.15 (.36)		Bfat +.01 (.22)			
Cow Eff.	150	BWt	WWt	WR	ADG	YWt	YR	Scr.	Fr.
		68	728	127	4	1265	122	37	5.0

★★★★★ for Low Maintenance, Growth, Marbling, Rib-eye area, High Cow Efficiency, Calving Ease, Stayability.

N-6 BECKTON NEBULA G S237
1-A 100% # 1118700 Tattoo: WF6 S237

Birth: 3-6-06
 Beckton Neptune R2 K065
BECKTON NEBULA M045
 Ref. N-1 Beckton Belga K285 JL
 Beckton Neptune RR B284
 Beckton Lana C735 TP
 Beckton Julian GG B571
 Beckton Belga G493 HR
 Beckton Julian GG B571
 Beckton Julian 7526G
 Bkt Marta 9A13 JL
BECKTON LAKME LA06 JL
 Beckton Lakme B370 HV
 Leachman Heavenly 8141
 Beckton Lakme 9211DT

DAM		Calv.Ease	BW	WW	YW	Milk	HPG	Stay	Maint.En.
Age	5	18	-4.6	25	55	6	13	14	-8.7
Wt	998	(.31)	(.69)	(.58)	(.51)	(.29)	(.01)	(.01)	(.16)
Wean Pct.	52%	Marb +.05 (.38)		REA +.21 (.35)		Bfat +.01 (.24)			
Cow Eff.	110	BWt	WWt	WR	ADG	YWt	YR	Scr.	Fr.
		63	519	88	4	1036	96	39	5.0

★★★★★ for Low Maintenance, Gainability, Rib-eye area, Calving Ease, Stayability.

• Reference Sires •

N-7 BECKTON NEBULA EN S347
1-A 100% # 1118810 Tattoo: WF6 S347

Birth: 3-13-06
 Beckton Nebula M045
BECKTON NEBULA E P084
 Ref. N
 Beckton Nebula M045
BECKTON EOLA P530 NB
 Beckton Eola M663 EP

DAM		Calv.Ease	BW	WW	YW	Milk	HPG	Stay	Maint.En.
Age	2	20	-8.5	16	39	12	13	18	-10.1
Wt	750	(.29)	(.68)	(.58)	(.51)	(.28)	(.01)	(.01)	(.12)
Wean Pct.	60%	Marb +.40 (.35)		REA +.01 (.31)		Bfat +.01 (.18)			
Cow Eff.	127	BWt	WWt	WR	ADG	YWt	YR	Scr.	Fr.
		55	521	97	4	1009	97	NA	4.5

★★★★★ for Low Maintenance, Gainability, Marbling, High Cow Efficiency, Calving Ease, Stayability.

N-10 BECKTON NEBULA T252 L3
1-A 100% # 1178762 Tattoo: BKT7 T252

Birth: 3-10-07
 Beckton Nebula M045
BECKTON NEBULA L P093
 Ref. N-2
 Beckton Nebula M045
BECKTON VERNICE L382 LN
 Beckton Vernice G373 WR

DAM		Calv.Ease	BW	WW	YW	Milk	HPG	Stay	Maint.En.
Age	6	14	-4.5	30	64	11	8	15	-3.6
Wt	1095	(.31)	(.60)	(.51)	(.44)	(.30)	(.15)	(.01)	(.15)
Wean Pct.	63%	Marb +.08 (.29)		REA +.26 (.27)		Bfat -.01 (.22)			
Cow Eff.	132	BWt	WWt	WR	ADG	YWt	YR	Scr.	Fr.
		75	684	124	4	1268	116	40	6.0

★★★★★ for Low Maintenance, Growth, Gainability, Rib-eye area, High Cow Efficiency, Calving Ease, Stayability.

N-8 BECKTON NEBULA PJ S543
1-A 100% # 1119006 Tattoo: BKT6 S543

Birth: 3-23-06
 Beckton Nebula M045
BECKTON NEBULA P P707
 Ref. N-3
 Beckton Lana M809 EP
 Beckton Julio L233
BECKTON LANA P685 JO
 Beckton Lana E083 CD

DAM		Calv.Ease	BW	WW	YW	Milk	HPG	Stay	Maint.En.
Age	2	17	-5.9	35	76	15	8	14	-3.2
Wt	1000	(.28)	(.69)	(.58)	(.51)	(.27)	(.01)	(.01)	(.12)
Wean Pct.	58%	Marb +.15 (.36)		REA +.19 (.33)		Bfat +.01 (.20)			
Cow Eff.	121	BWt	WWt	WR	ADG	YWt	YR	Scr.	Fr.
		68	661	126	4	1216	120	35	6.5

★★★★★ for Low Maintenance, Growth, Gainability, Marbling, Rib-eye area, High Cow Efficiency, Calving Ease, Stayability.

N-11 BECKTON NEBULA T398 V3
1-A 100% # 1178446 Tattoo: BKT7 T398

Birth: 3-17-07
 Beckton Nebula M045
BECKTON NEBULA L P093
 Ref. N-2
 Beckton Marta M021 LN
 Beckton Vegas PK F485
BECKTON MINERVA J615 VG
 Beckton Minerva F433 VG

DAM		Calv.Ease	BW	WW	YW	Milk	HPG	Stay	Maint.En.
Age	8	10	-0.8	38	72	10	10	12	-5.9
Wt	1175	(.32)	(.61)	(.52)	(.45)	(.31)	(.14)	(.11)	(.15)
Wean Pct.	52%	Marb +.11 (.29)		REA +.22 (.28)		Bfat -.01 (.21)			
Cow Eff.	110	BWt	WWt	WR	ADG	YWt	YR	Scr.	Fr.
		77	611	110	4	1234	113	40	6.0

★★★★★ for Low Maintenance, Growth, Gainability, Marbling, Rib-eye area, Calving Ease.

N-9 BECKTON NEBULA T054 H3
1-A 100% # 1178349 Tattoo: BKT7 T054

Birth: 2-18-07
 Beckton Nebula M045
BECKTON NEBULA J R475
 Ref. N-5
 Beckton Larkeisa M138 JC
 Beckton Hustler C2 L079
BKT PINE MARIE R401 HU
 Bkt Pine Marie LC30 CD

DAM		Calv.Ease	BW	WW	YW	Milk	HPG	Stay	Maint.En.
Age	2	15	-4.6	24	60	8	13	14	-6.4
Wt	995	(.27)	(.58)	(.48)	(.41)	(.26)	(.01)	(.01)	(.01)
Wean Pct.	44%	Marb +.10 (.26)		REA +.41 (.25)		Bfat -.01 (.20)			
Cow Eff.	93	BWt	WWt	WR	ADG	YWt	YR	Scr.	Fr.
		67	507	91	5	1135	106	35	5.0

★★★★★ for Low Maintenance, Gainability, Rib-eye area, Calving Ease, Stayability.



Tongue River Nebula TT779

• Reference Sires •

N-12 TR NEBULA TT779
1-A 100% # 1183333 Tattoo: TR2A7 TT7

Birth: 2-18-07
 Beckton Neptune R2 K065
BECKTON NEBULA M045
 Ref. N-1
 Beckton Belga K285 JL
 Beckton Neptune RR B284
 Beckton Lana C735 TP
 Beckton Julian GG B57
 Beckton Belga G493 HR
 Beckton Lancer TS D390
 Beckton Tara D565 CB
TR LYDIA MT244
 Beckton Lancer F134 TS
 Beckton Lydia E251 CL
 Beckton Clipper ER C360
 Beckton Lydia C180 CF

Calv.Ease	BW	WW	YW	Milk	HPG	Stay	Maint.En.
12	-2.4	33	64	14	12	13	-4.0
(.29)	(.52)	(.45)	(.40)	(.29)	(.01)	(.01)	(.15)
Marb +.17 (.30)		REA +.00 (.29)		Bfat +.00 (.22)			
BWt	WWt	WR	ADG	YWt	YR	Scr.	Fr.
79	721	117	4	1263	110	39	5.5

DAM	
Age	6
Wt	1240
Wean Pct.	58%
Cow Eff.	NA

★★★★★ for Low Maintenance, Growth, Marbling, Calving Ease, Stayability.

W-1 BECKTON WARRIOR N645 T1
1-A 100% # 916767 Tattoo: BKT3 N645

Birth: 4-2-03
 Beckton Warrior TC E801
BECKTON WARRIOR T1 H281
 Ref. W
 Beckton Minerva B609 RN
 Beckton Warrior T C371
 Beckton Minola C251 NM
 Beckton Ranger H Z095
 Beckton Minerva Z936 RN
 Beckton Epic D404
 Beckton Belga D483 KR
BECKTON ROSE H074 EP
 Beckton Epic K F075
 Beckton Rose F791 EM
 Beckton Emperor C369
 Beckton Rose C794 KR

Calv.Ease	BW	WW	YW	Milk	HPG	Stay	Maint.En.
5	-0.2	40	78	8	9	10	-1.0
(.31)	(.66)	(.54)	(.45)	(.27)	(.15)	(.01)	(.16)
Marb -.01 (.36)		REA +.01 (.34)		Bfat +.01 (.23)			
BWt	WWt	WR	ADG	YWt	YR	Scr.	Fr.
85	679	117	3	1204	115	37	6.5

DAM	
Age	5
Wt	1020
Wean Pct.	67%
Cow Eff.	140

★★★★★ for Low Maintenance, Growth, High Cow Efficiency.

R-1 BECKTON RANGER T603 H3
1-A 100% # 1178895 Tattoo: WF7 T603

Birth: 3-27-07
 Beckton Ranger 7003
BECKTON RANGER 9479R
 Ref. R
 Beckton Eola 7470 RZ
 Beckton Varo 5642
 Bkt Migo Vernice3942
 Beckton Raza 2308-N
 Bkt Neva Eola 4829
 Beckton Hustler CN J102
 Beckton Barmmaid J012 CO
BECKTON ROSE N044 HU
 Beckton Hustler C2 L079
 Beckton Rose L669 JL
 Beckton Julian 7526G
 Beckton Rose D389 RD

Calv.Ease	BW	WW	YW	Milk	HPG	Stay	Maint.En.
11	-3.0	26	49	8	9	9	-9.8
(.29)	(.54)	(.45)	(.41)	(.29)	(.01)	(.17)	(.13)
Marb +.11 (.29)		REA -.21 (.28)		Bfat +.01 (.24)			
BWt	WWt	WR	ADG	YWt	YR	Scr.	Fr.
84	637	106	4	1185	106	35	5.5

DAM	
Age	4
Wt	1085
Wean Pct.	56%
Cow Eff.	118

★★★★★ for Low Maintenance, Gainability, Marbling, High Cow Efficiency, Calving Ease.

W-2 BECKTON WARRIOR C1 S337
1-A 100% # 1118800 Tattoo: WF6 S337

Birth: 3-12-06
 Beckton Warrior C C355
BECKTON WARRIOR CL M686
 Ref. W
 Beckton Christy J223 LN
 JKG Chiefton L303
 Bkt Christy 9A01 CL
 Beckton Lancer TL G626
 Beckton Christy G249 JL
 Beckton Cody C401
 Beckton Birdie C353 VG
BECKTON CHRISTY K101 CD
 Beckton Cody V E023
 Beckton Christy C306 JL
 Beckton Julian 7526G
 Beckton Christy Z264 NP

Calv.Ease	BW	WW	YW	Milk	HPG	Stay	Maint.En.
16	-4.1	29	60	15	14	12	2.0
(.32)	(.70)	(.60)	(.53)	(.30)	(.01)	(.12)	(.16)
Marb +.05 (.40)		REA +.28 (.37)		Bfat +.00 (.23)			
BWt	WWt	WR	ADG	YWt	YR	Scr.	Fr.
81	682	116	5	1249	112	36	5.5

DAM	
Age	6
Wt	1085
Wean Pct.	63%
Cow Eff.	132

★★★★★ for Low Maintenance, Gainability, Rib-eye area, High Cow Efficiency, Calving Ease.



Beckton Warrior N645 T1

W-3 BECKTON WARRIOR T248 L5
1-A 100% # 1178758 Tattoo: WF7 T248

Birth: 3-11-07
 Beckton Warrior T1 H281
BECKTON WARRIOR N645 T1
 Ref. W-1
 Beckton Rose H074 EP
 Beckton Warrior TC E801
 Beckton Minerva B609 RN
 Beckton Epic K F075
 Beckton Rose F791 EM
 Beckton Lancer T A664
 Bkt Suffeina A828 DM
BECKTON KIT R503 LN
 Beckton Lancer F442 T
 Beckton Kit F468 JL
 Beckton Julian GG B571
 Beckton Kit A517 NP

Calv.Ease	BW	WW	YW	Milk	HPG	Stay	Maint.En.
10	-1.4	30	61	8	10	16	-6.3
(.28)	(.57)	(.47)	(.41)	(.27)	(.01)	(.01)	(.01)
Marb +.01 (.29)		REA +.37 (.28)		Bfat +.00 (.23)			
BWt	WWt	WR	ADG	YWt	YR	Scr.	Fr.
70	602	108	4	1136	106	37	5.0

DAM	
Age	2
Wt	830
Wean Pct.	63%
Cow Eff.	133

★★★★★ for Low Maintenance, Growth, Rib-eye area, High Cow Efficiency, Calving Ease, Stayability.

RAAA Herd EPD Tables

Proven and Genetic Opportunity Sires (2010)

	CED	BW	WW	YW	MILK	TM	ME	HPG	CEM	ST	MARB	REA	FAT
Min	-14	-8.7	-7	-6	-9	0	-19	-5	-14	0	-.50	-.74	-.05
Avg	6	-0.2	32	60	17	33	4	9	4	9	.06	.05	.00
Max	29	9.1	65	111	37	56	23	21	25	19	.65	.89	.06
1%	18	-6.2	55	100	31	52	-8	16	14	16	.37	.56	-.03
2%	16	-5.5	52	95	29	50	-7	16	13	16	.34	.50	-.03
3%	15	-5.0	50	92	28	48	-6	15	12	15	.31	.46	-.02
4%	15	-4.7	49	90	28	47	-5	15	11	15	.29	.43	-.02
5%	14	-4.4	48	88	27	46	-5	14	11	14	.28	.41	-.02
10%	12	-3.5	45	82	25	43	-3	13	9	13	.23	.33	-.02
15%	11	-2.9	42	78	23	41	-2	12	8	12	.20	.28	-.01
20%	10	-2.4	40	75	22	40	0	12	8	12	.17	.23	-.01
25%	9	-1.9	39	72	21	38	0	11	7	11	.15	.20	-.01
30%	9	-1.5	37	69	20	37	1	11	6	11	.13	.16	-.01
35%	8	-1.2	36	67	19	36	2	10	6	10	.11	.13	.00
40%	7	-0.9	34	64	19	35	3	10	5	10	.09	.11	.00
45%	7	-0.5	33	62	18	34	3	9	5	9	.08	.08	.00
50%	6	-0.2	32	60	17	33	4	9	4	9	.06	.05	.00
55%	5	0.1	31	58	16	32	5	9	3	9	.04	.02	.00
60%	5	0.5	30	56	15	31	5	8	3	8	.03	-.01	.00
65%	4	0.8	28	53	15	30	6	8	2	8	.01	-.03	.00
70%	3	1.1	27	51	14	29	7	7	2	7	-.01	-.06	.01
75%	3	1.5	25	48	13	28	8	7	1	7	-.03	-.10	.01
80%	2	2.0	24	45	12	26	8	6	0	6	-.05	-.13	.01
85%	1	2.5	22	42	11	25	10	6	0	6	-.08	-.18	.01
90%	0	3.1	19	38	9	23	11	5	-1	5	-.11	-.23	.02
95%	-2	4.0	16	32	7	20	13	4	-3	4	-.16	-.31	.02

Active Cows (2010)

	CED	BW	WW	YW	MILK	TM	ME	HPG	CEM	ST	MARB	REA	FAT
Min	-11	-9.0	-12	-21	-11	-13	-24	-4	-14	-1	-.33	-.77	-.05
Avg	5	0.2	30	53	16	31	4	9	3	9	.05	.01	.00
Max	24	11.7	67	114	41	65	44	21	16	21	.77	.73	.06
1%	14	-4.8	48	86	29	49	-7	14	11	16	.32	.41	-.02
2%	13	-4.2	46	82	27	47	-5	14	10	15	.29	.36	-.02
3%	12	-3.8	45	79	26	45	-5	13	9	14	.27	.33	-.02
4%	12	-3.5	44	78	26	44	-4	13	9	14	.26	.31	-.02
5%	11	-3.3	43	76	25	44	-4	13	9	14	.24	.29	-.02
10%	10	-2.5	40	71	23	41	-2	12	7	13	.20	.23	-.01
15%	9	-2.0	38	68	22	39	-1	11	7	12	.17	.19	-.01
20%	8	-1.6	37	65	21	37	0	11	6	11	.15	.15	-.01
25%	8	-1.2	35	62	20	36	1	11	5	11	.13	.12	-.01
30%	7	-0.9	34	60	19	35	2	10	5	11	.11	.10	-.01
35%	6	-0.6	33	58	18	34	2	10	4	10	.10	.08	.00
40%	6	-0.3	32	57	17	33	3	10	4	10	.08	.05	.00
45%	5	-0.1	31	55	17	32	3	9	3	9	.06	.03	.00
50%	5	0.2	30	53	16	31	4	9	3	9	.05	.01	.00
55%	5	0.5	29	51	15	30	5	9	3	9	.04	-.01	.00
60%	4	0.7	28	49	15	29	5	8	2	8	.02	-.03	.00
65%	4	1.0	27	48	14	28	6	8	2	8	.00	-.06	.00
70%	3	1.3	26	46	13	27	6	8	1	7	-.01	-.08	.01
75%	2	1.6	25	44	12	26	7	7	1	7	-.03	-.10	.01
80%	2	2.0	23	41	11	25	8	7	0	7	-.05	-.13	.01
85%	1	2.4	22	38	10	23	9	7	-1	6	-.07	-.17	.01
90%	0	2.9	20	35	9	21	10	6	-1	5	-.10	-.21	.01
95%	-1	3.7	17	30	7	18	12	5	-3	4	-.14	-.27	.02

Non-Parents (2010)

	CED	BW	WW	YW	MILK	TM	ME	HPG	CEM	ST	MARB	REA	FAT
Min	-11	-9.9	-9	-15	-3	-5	-17	-1	-11	0	-.32	-.54	-.03
Avg	5	0.0	31	58	17	33	4	9	3	9	.08	.08	.00
Max	22	11.9	66	121	34	60	23	18	17	21	.59	.81	.04
1%	14	-4.9	49	90	28	49	-5	14	10	16	.33	.47	-.02
2%	13	-4.3	47	86	27	47	-4	13	9	15	.30	.43	-.02
3%	12	-3.9	45	84	26	46	-3	13	8	15	.29	.40	-.01
4%	12	-3.7	44	82	25	45	-3	12	8	14	.27	.37	-.01
5%	11	-3.5	44	81	25	45	-2	12	8	14	.26	.36	-.01
10%	10	-2.7	41	76	23	42	-1	12	7	13	.22	.30	-.01
15%	9	-2.2	39	72	22	40	0	11	6	12	.19	.25	-.01
20%	8	-1.8	37	70	21	39	1	11	5	11	.17	.22	-.01
25%	8	-1.4	36	67	20	38	1	10	5	11	.15	.19	-.01
30%	7	-1.1	35	65	19	37	2	10	4	11	.14	.17	.00
35%	6	-0.8	34	63	19	36	3	10	4	10	.12	.14	.00
40%	6	-0.5	33	61	18	35	3	9	4	10	.11	.12	.00
45%	5	-0.3	32	60	18	34	4	9	3	9	.09	.10	.00
50%	5	0.0	31	58	17	33	4	9	3	9	.08	.08	.00
55%	5	0.3	30	56	16	32	4	9	3	9	.07	.06	.00
60%	4	0.5	29	55	16	31	5	9	2	8	.05	.04	.00
65%	4	0.8	28	53	15	30	5	8	2	8	.04	.02	.00
70%	3	1.1	27	51	15	29	6	8	2	7	.02	-.01	.00
75%	2	1.4	26	49	14	28	7	8	1	7	.01	-.03	.01
80%	2	1.8	25	46	13	27	7	7	1	7	-.01	-.06	.01
85%	1	2.2	23	44	12	26	8	7	0	6	-.03	-.09	.01
90%	0	2.7	21	40	11	24	9	6	-1	5	-.06	-.14	.01
95%	-1	3.5	18	35	9	21	10	6	-2	4	-.10	-.20	.01

EPD Accuracies and Possible Change

EPDs are predictions, not true values, and we can therefore expect that EPDs will change from sire evaluation, as more information (i.e. progeny data) is included. A possible change value is an estimate of the amount of change (in trait units) that can be expected for a given EPD.

Technically, there is a 68% chance that the real genetic value (an EPD with a accuracy of 1.0) for any trait lies between its EPD plus its possible change value and its EPD minus its possible change value. For example, if a sire has a weaning EPD of +25 lb. and a possible change value of 10 lb., we can expect the true genetic value to be between +15 lb. (25 - 10) and +35 lb. (25 + 10) 68% of the time. We should not be surprised if his EPD in next year's evaluation is as high as +35 or as low as +15. If next year's EPD should happen to be slightly outside of this

range, keep in mind there is nearly a one-in-three chance of that happening; however, significantly larger deviations can occur.

Possible change is simply another way of expressing accuracy of an EPD. High accuracy sires will have small possible changes and vice versa. Many breeders feel that possible change values complement accuracies and help them determine just how thoroughly an animal has been evaluated. The accuracy/possible change chart lists possible changes in EPDs that can be expected with different levels of accuracy for the various traits.

For more information on possible change values, please see the article by Dr. Bob Hough titled "Understanding EPD Accuracies and Possible Change". This article can be downloaded from the Red Angus Association of America website at www.redangus.org.

Accuracy	CED	BW	WW	YW	MILK	ME	HPG	CETM	ST	MARB	REA	FAT
0.0	9	3.0	12	15	9	3	11	9	7	.24	.31	.03
0.1	8	2.7	11	14	8	2	10	8	6	.22	.28	.03
0.2	7	2.4	9	12	7	2	9	7	5	.19	.25	.02
0.3	6	2.1	8	11	6	2	8	6	5	.17	.22	.02
0.4	5	1.8	7	9	5	2	7	5	4	.14	.19	.02
0.5	4	1.5	6	8	4	1	6	4	3	.12	.16	.01
0.6	3	1.2	5	6	4	1	4	4	3	.10	.12	.01
0.7	3	0.9	4	5	3	1	3	3	2	.07	.09	.01
0.8	2	0.6	2	3	2	1	2	2	1	.05	.06	.01
0.9	1	0.3	1	2	1	0	1	1	1	.02	.03	.00
1.0	0	0.0	0	0	0	0	0	0	0	.00	.00	.00

Sire Bloodline Charts

Name Family

- Action C
- Champ H
- Clifftop B
- Clipper C
- Cobalt C
- Cody C
- Colt C
- Copper B
- Dominor D
- Emcee E
- Emperor E
- Epic E
- Epitomy E
- Exeter E
- Hasten H
- Herald H
- Heritage H
- Hilltop B
- Hustler H
- Javelin L
- Jet J
- Jules J
- Julian J
- Julio J
- Juniper J
- Juno J
- Jupiter J
- Justice J
- Lancer L
- Lariat L
- Legend L
- Likable L
- Loki L
- Nebula N
- Neptune N
- Neva V
- Nomad V
- Ranger R
- Roman J
- Scamp J
- Varo R
- Vega V
- Vegas V
- Warhawk W
- Warrior W

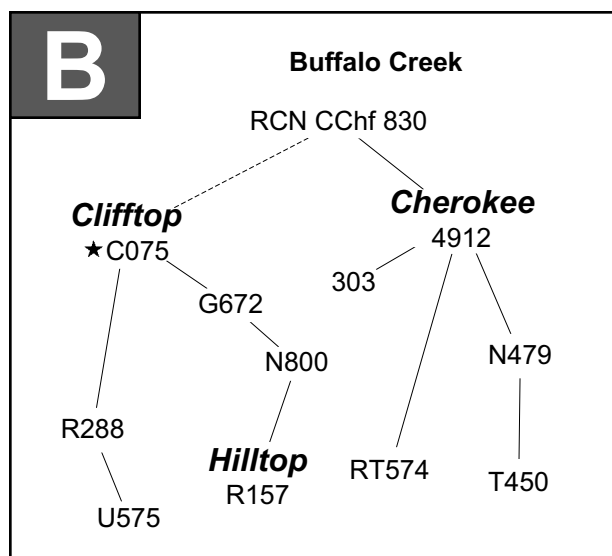
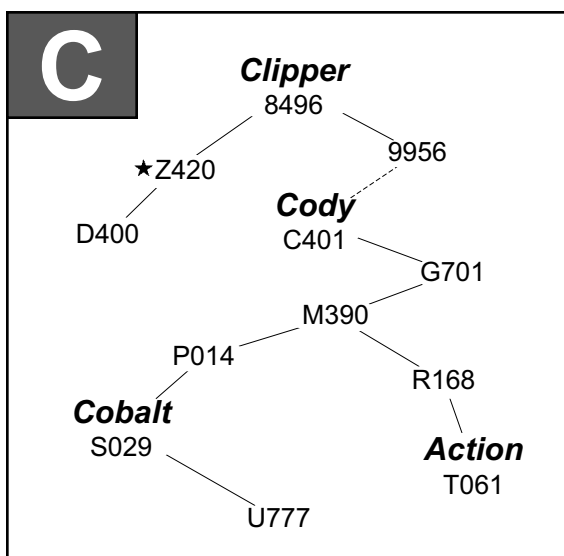
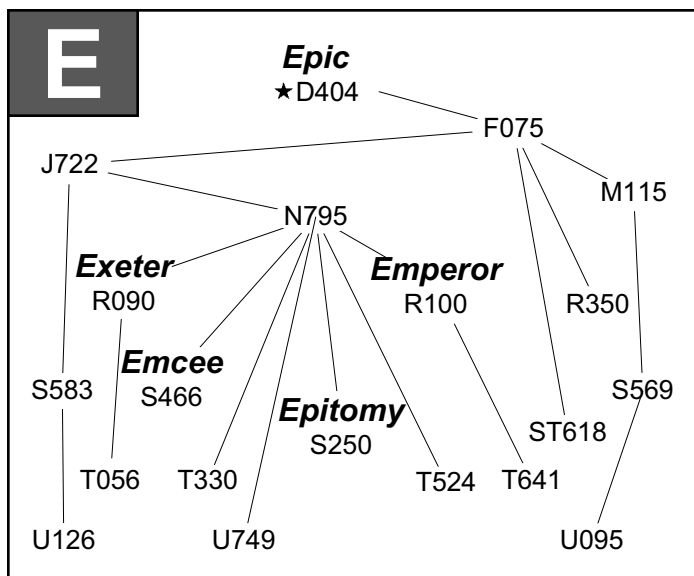
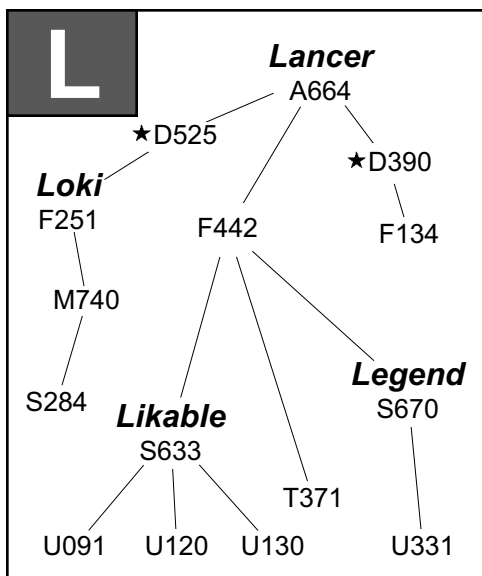
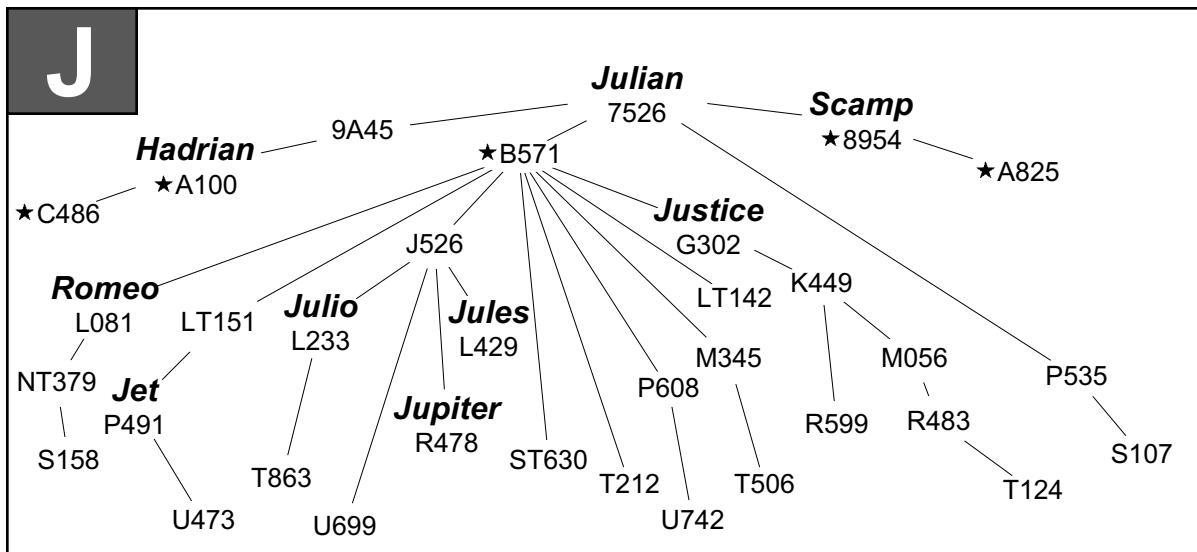

★ Red Angus Trait Leader

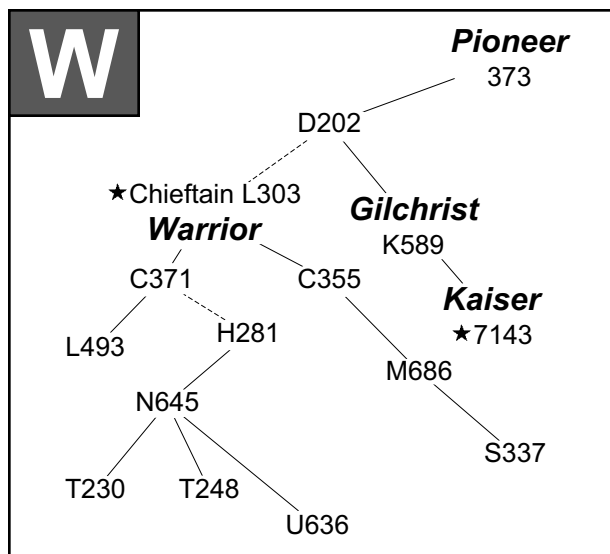
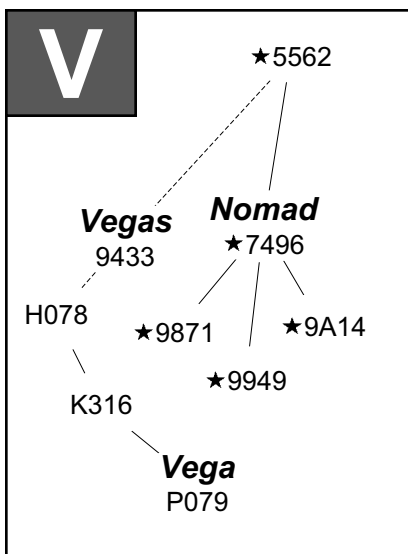
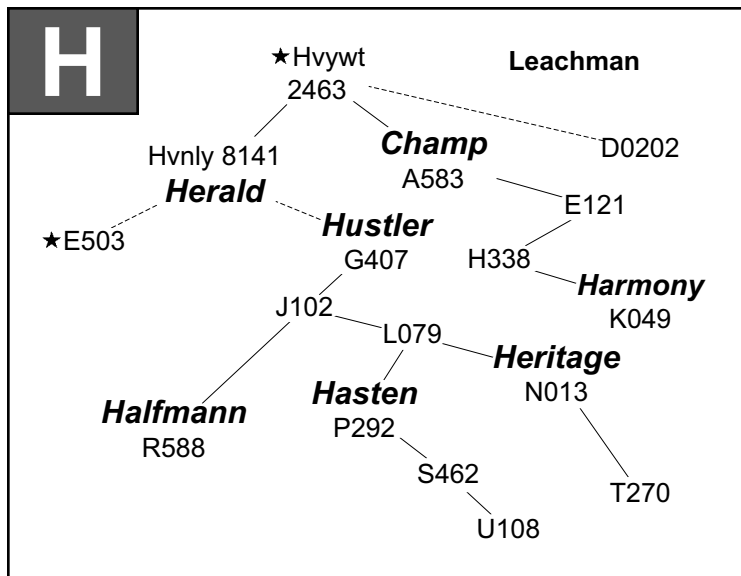
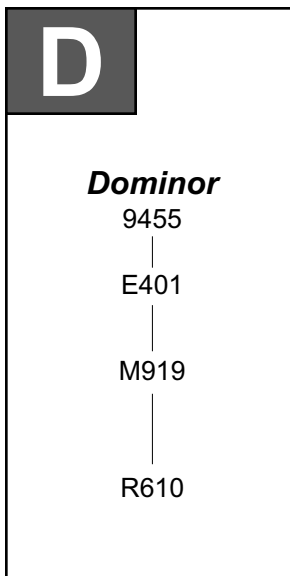
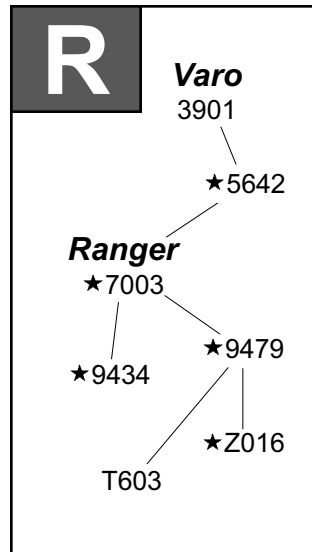
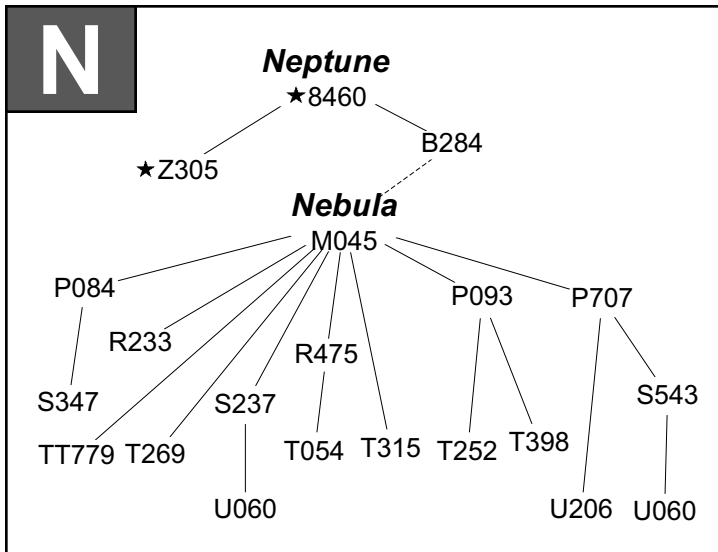

Name	Tag	Family
Julian	B571	J-1
Lancer	F442	L-1
Julio	L233	J-2
Julian	LT151	J-12
Nebula	M045	N-1
Justice	M056	J-3
Epic	M115	E-1
Julian	M345	J
Heritage	N013	H-1
Cherokee	N479	B
Warrior	N645	W-1
Epic	N795	E-2
Cody	P014	C-1
Vega	P079	V
Nebula	P084	N
Nebula	P093	N-2
Jet	P491	J-4
Julian	P535	J
Julian	P608	J-5
Nebula	P707	N-3
Cody	R168	C
Nebula	R233	N-4
Clifftop	R288	B-1
Epic	R350	E-3
Nebula	R475	N-5
Justice	R483	J-6
Nebula	R573	N-6
Halfmann	R588	H-2
Dominor	R610	D-1
Cobalt	S029	C
Julian	S107	J-7
Roman	S158	J-8
Nebula	S237	N-7
Epitomy	S250	E-4
Loki	S284	L-2
Warrior	S337	W-2
Nebula	S347	N-8
Hasten	S462	H-3
Emcee	S466	E-5
Nebula	S543	N-9
Epic	S569	E-6
Epic	S583	E
Likable	S633	L
Legend	S670	L
Nebula	T054	N-10
Exeter	T056	E
Action	T061	C-2
Justice	T124	J-9
Julian	T212	J
Warrior	T230	W
Warrior	T248	W-3
Nebula	T252	N-11
Nebula	T269	N
Heritage	T270	H-4
Nebula	T315	N
Epic	T330	E
Lancer	T371	L-3
Nebula	T398	N-12
Cherokee	T450	B
Julian	T506	J
Epic	T524	E
Ranger	T603	R-1
Julian	T612	J
Emperor	T641	E-7
Julio	T863	J-10

Lot-Tag Cross Reference

ID	Lot	ID	Lot	ID	Lot	ID	Lot	ID	Lot	ID	Lot	ID	Lot
<i>Reference Sires</i>		<i>Beckton Bulls</i>		W210	140	W377	141	W605	64	W814	205	<i>Tongue River Bulls</i>	
B571	J-1	W004	34	W218	96	W383	215	W608	144	W818	214	WT951	72
F442	L-1	W006	61	W219	147	W390	143	W614	169	W821	126	WT952	8
LT142	J-9	W014	89	W220	196	W391	187	W616	26	W825	195	WT953	182
LT151	J-10	W016	191	W221	65	W396	114	W618	127	W828	39	WT954	131
M045	N-1	W024	94	W222	32	W398	164	W630	44	W835	111	WT955	132
N645	W-1	W026	139	W225	35	W411	136	W632	201	W836	172	WT957	181
N795	E-1	W027	5	W226	4	W412	50	W633	108	W838	212	WT961	130
P014	C-1	W030	80	W228	90	W420	63	W638	163	W852	225	WT963	73
P093	N-2	W041	199	W230	48	W421	76	W647	192	W876	218	WT964	75
P491	J-2	W054	97	W231	29	W430	27	W648	125			WT965	180
P608	J-3	W067	194	W234	137	W437	162	W652	197	<i>Beckton Heifers</i>		WT967	184
P707	N-3	W070	148	W236	42	W442	33	W657	88	W088	324	WT969	129
R233	N-4	W071	185	W239	207	W444	82	W660	116	W145	326	WT972	16
R288	B-1	W072	83	W249	70	W446	23	W665	41	W161	305	WT974	71
R350	E-2	W074	67	W252	98	W447	30	W669	113	W196	301	WT976	134
R475	N-5	W085	155	W256	224	W450	203	W670	86	W215	321	WT977	74
R483	J-4	W087	119	W259	190	W452	62	W672	145	W235	308	WT981	7
R588	H-1	W091	60	W260	49	W454	142	W676	122	W261	322	WT985	133
R610	D-1	W094	150	W270	25	W455	101	W680	213	W262	320	WT987	183
RT574	B-2	W100	151	W274	217	W460	9	W681	120	W263	302	WT989	15
S107	J-5	W105	95	W276	59	W466	110	W683	124	W275	323		
S158	J-6	W109	66	W282	21	W469	47	W690	102	W296	304	<i>Tongue River Heifers</i>	
S237	N-6	W112	36	W292	81	W476	104	W694	179	W322	307	WT904	318
S250	E-3	W114	115	W293	2	W498	14	W698	216	W332	328	WT906	330
S284	L-2	W115	165	W298	19	W500	156	W703	149	W435	325	WT908	333
S337	W-2	W116	118	W299	186	W509	87	W711	198	W474	306	WT912	329
S347	N-7	W119	78	W300	46	W515	211	W713	161	W624	327	WT914	310
S462	H-2	W120	154	W302	20	W517	117	W718	84	W744	303	WT916	312
S466	E-4	W131	38	W312	6	W520	123	W719	79			WT917	336
S543	N-8	W140	68	W315	43	W527	173	W722	160			WT918	338
S569	E-5	W142	18	W317	24	W529	109	W724	222			WT919	317
ST618	E-7	W146	202	W318	51	W537	52	W725	31			WT920	337
ST630	J-11	W148	58	W320	28	W540	93	W728	153			WT921	335
T054	N-9	W151	220	W327	37	W546	54	W734	175			WT922	340
T061	C-2	W152	22	W328	13	W548	208	W746	167			WT923	311
T124	J-7	W154	12	W329	146	W549	210	W749	219			WT924	339
T248	W-3	W163	92	W339	103	W556	11	W753	135			WT926	309
T252	N-10	W168	99	W342	91	W560	206	W758	168			WT928	319
T270	H-3	W173	112	W343	1	W561	158	W759	171			WT929	314
T371	L-3	W176	10	W344	176	W574	45	W763	223			WT931	315
T398	N-11	W179	77	W347	152	W588	204	W766	157			WT933	332
T603	R-1	W181	85	W349	121	W592	107	W768	209			WT934	313
T641	E-6	W184	138	W354	55	W595	69	W769	174			WT935	331
T863	J-8	W185	53	W356	170	W597	193	W777	105			WT936	334
TT779	N-12	W190	159	W358	106	W598	200	W784	100			WT937	316
		W191	17	W367	166	W599	56	W801	177				
		W201	188	W372	3	W601	189	W802	178				
		W207	40	W374	128	W602	57	W805	221				

Sale Terms and Conditions

Except for those stated in the terms and conditions below, there are no warranties, either expressed or implied, as to the merchantability or fitness for a particular purpose with respect to the cattle being sold at this auction. The warranties and guarantees set forth in the "Terms and Conditions" are in lieu of all other warranties, either expressed or implied, and the remedies provided therein shall be the sole and exclusive remedy for the Buyer, or any party claiming through Buyer, for any breach of warranty or guarantee therein provided, and all other obligations or liabilities.

The information in the catalog is believed to be accurate, and the information seller believes to be most representative. It is the nature of seller's business that the seller engages in a continual process of collecting new data and information. Therefore, any information presented at the time of sale is always subject to revision, correction or update.

I. BIDDING

The Auctioneer in charge will settle any disputes as to bids, and his decision on such matters shall be final.

II. TERMS

Terms of sale are cash or personal check unless satisfactory credit arrangements have been made with vendor prior to sale.

III. PURCHASER'S RISK

Each animal becomes the risk of the purchaser as soon as sold, but it shall be the obligation of the Seller to see that animals are fed and cared for free of charge to purchaser, until loaded for shipment or until the expiration of 48 hours after the sale, whichever occurs sooner.

IV. DELIVERY

For any animals for which delivery or 'free delivery' is offered, the following terms shall apply. Each animal becomes the risk of the purchaser as soon as sold, and through the time of delivery. The seller will arrange transportation and delivery schedules, and may combine animals from one or more purchasers for convenience and to reduce costs. If 'free delivery' is offered, seller will pay the cost of transportation, but assumes no other liability. Once the purchaser has been notified of the date and approximate time of delivery (morning, afternoon, evening, etc.), it is the responsibility of the purchaser to arrange adequate and agreeable location and facilities for unloading each animal. When unloaded at the agreed upon location, all care and management of the animal is the responsibility of the purchaser.

V. CERTIFICATE OF REGISTRY

A transferred certificate of registry will be furnished to the purchaser for each animal.

VI. HEALTH

All animals are eligible for interstate shipment, except as otherwise announced. Interstate health papers will be furnished for each animal requiring T.B. and Bang's tests in accordance with Federal Regulations.

VII. A.I. NON-OWNER BULL PERMITS

A.I./Non-owner Bull Permits shall be furnished by the Seller, at no cost to the Buyer, for all females bred artificially or naturally to bulls not owned by the Seller.

VIII. ANNOUNCEMENTS

Any changes from information of any kind in this catalog will be announced from the auction box and such announcements shall take precedence.

IX. BREEDING GUARANTEE

All animals are sold as guaranteed breeders. Each bull has been officially fertility tested as "Satisfactory Breeder" prior to the sale. However, seller cannot guarantee against physical injury or illness following the sale. But if within 8 months following the sale, the buyer has evidence that the animal is not a breeder, the buyer may obtain a statement signed by a licensed veterinarian to that effect, such statement also indicating that there has been no injury or illness to the animal following the sale, and return the bull to the farm of the seller for adjustment. If the seller cannot then prove the animal to be a breeder, an adjustment will be made by the seller, either by substituting an animal of equal value, or by the refund of the full purchase price. Such adjustment shall be considered full settlement and satisfaction of all claims. No guarantees apply to animals which are shown following the sale.

Any female that has had a calf prior to the date of sale shall be considered a breeder without further guarantee. Any female that has not had a calf prior to the sale, and which fails to conceive after having been exposed to a bull of demonstrated fertility for at least 60 days, may be returned to the seller at the buyer's expense for a full refund of the purchase price. Such refund shall be considered full adjustment and no further adjustment or compensation shall be due. All pedigree and breeding information represents the best estimate at the time it is collected, but is subject to revision or correction in the future.

X. GENETIC DEFECT AND PARENTAGE GUARANTEE

For complete rules and regulations in regard to genetic defects or parentage guarantee contact the RAAA. Ask for section XI - in the Sales and Terms Recommended policy.

XI. RETAINED INTEREST AND SEMEN RIGHTS:

Buyer receives full possession and salvage value of all bulls in the sale, unless stated otherwise in the catalog or during the auction. On specific animals designated in the catalog or from the auction block, Seller is retaining an undivided 1/2 interest or other interest as stated. We reserve the right to collect and market semen on these bulls. Collection would be during the off season, at the buyer's convenience, and at seller's expense. The buyer has the option of obtaining semen at the same time, at cost, provided we are notified ahead of collection. If the buyer collects the bull, we would like to be notified so we may obtain semen if wanted.

On all other bulls in the Sale, except those so designated, the buyer has full possession, and shall have the sole privilege to determine if the bull is to have semen collected at any time in the future. On such bulls which are collected in the future, and from which semen is advertised or marketed commercially, seller retains a 1/3 royalty interest on all gross semen and certificate sales. On bulls which are collected by buyer, seller may pay his pro-rated share of collection costs, for which seller obtains semen and certificates for his own in-herd use. However, any decision to collect or sell semen, and the timing of such collection, is solely the right of the buyer.

XII. RIGHTS AND OBLIGATIONS

A. The above terms and conditions of sale shall constitute a contract between the Buyer and Seller of each animal and shall be equally binding upon both. Each sale or resale of an animal constitutes a separate transaction.

B. Neither the sale manager, the owner, nor any other person connected with the management of the sale, assumes any liability, legal or otherwise.

The Red Angus Association along with animal scientists have developed a DNA marker test for osteopetrosis (OS), a genetic disorder which in rare instances can cause the loss of a calf at birth. Since the test was developed, Beckton has tested every sire being used in our breeding program. Only one sire, from outside our program, tested positive as a carrier of the gene. Every sire bred and raised at Beckton has tested 'Free'. All of our major semen sires have also been tested 'Free'. We guarantee every sale animal to be OS Free, and if you have a concern, we will have any sale animal tested on request. If an animal were to test positive, we would replace the animal or refund the purchase price. The testing we have done shows no incidence of occurrence in any Beckton bloodlines for the past 30 years, and so we believe there is no safer herd than ours.

Notes

Semen Available



Bull Name	Calv. Ease	BW	WW	YW	Milk	HPG	Stay	ME	Marb	REA	Bfat	Price
	Acc.	Acc.	Acc.	Acc.	Acc.	Acc.	Acc.	Acc.	Acc.	Acc.	Acc.	
Beckton Lancer T A664	15	-3.0	28	59	6	-1	14	7.0	.25	.01	-.01	\$18/60
Reg. 358389	.89	.92	.90	.90	.89	.80	.77	.62	.74	.72	.60	
Beckton Clifftop T C075	14	-5.7	20	44	12	10	15	-3.0	.01	.20	-.02	\$18/60
Reg. 421391	.76	.82	.79	.79	.76	.62	.65	.57	.63	.59	.46	
Beckton Jules L429	16	-6.7	20	39	17	5	12	0.0	-.02	.14	.01	\$18/60
Reg. 793522	.58	.78	.71	.68	.57	.28	.01	.46	.46	.42	.26	
Beckton Cody KH M390	13	-4.5	26	57	13	9	12	-4.0	.01	-.07	.02	\$18/60
Reg. 854892	.47	.76	.67	.62	.45	.01	.01	.34	.44	.41	.27	
Beckton Cherokee N N479	14	-5.6	31	50	25	11	13	-4.6	.08	.27	.02	\$18/60
Reg. 916601	.63	.76	.72	.70	.63	.36	.30	.42	.50	.47	.32	
Beckton Warrior N645 T1	5	-0.2	40	78	8	9	10	-1.0	-.01	.01	.01	\$18/60
Reg. 916767	.31	.66	.54	.45	.27	.15	.01	.16	.36	.34	.23	
Beckton Epic K4 N795	7	-0.6	35	88	11	2	12	4.6	.27	.16	.01	\$18/60
Reg. 916917	.71	.82	.78	.77	.71	.40	.20	.49	.48	.44	.26	
Beckton Nebula L P093	13	-3.0	34	69	3	13	13	-5.2	.11	.36	-.01	\$18/60
Reg. 978419	.65	.83	.77	.74	.65	.33	.01	.38	.46	.42	.25	
Beckton Jet L P491	19	-8.1	14	34	19	11	15	2.0	.19	.15	.00	\$18/60
Reg. 978816	.57	.76	.69	.67	.58	.10	.25	.43	.44	.40	.24	
Beckton Julian G4 P627	17	-3.7	23	42	11	15	15	-9.8	.17	.21	.01	\$18/60
Reg. 978951	.48	.70	.63	.61	.48	.37	.21	.32	.47	.44	.31	
Beckton Epic R350 K	11	-3.7	25	54	17	11	11	1.0	.14	.09	.01	\$18/60
Reg. 1042088	.23	.26	.25	.25	.25	.19	.17	.18	.01	.01	.01	
Beckton HalfmannHustler R588	12	-4.5	32	67	11	7	11	5.0	-.11	-.04	-.02	\$18/60
Reg. 1042326	.21	.36	.28	.29	.23	.16	.01	.16	.30	.28	.22	

Beckton History



Sal keeping records.



Waldo Forbes - 1st President of the Red Angus Association.



Beckton house/office before being moved in 1905 to its current location. This house was built in the 1880s by George Beck, the original homesteader. The antlers are still on the porch, and it is one of the oldest buildings in Sheridan County.



The Waldo Forbes family in 1959: Ellen, Julia, Sal, Sarah, Cherry,, Spike, and Cam & Elfie in front.



Inspection Committee at Beckton (1954), including George and Vernice Chiga, Sal and Waldo Forbes and Spike.



Beckton Larkabeau O "220" in 1959 - the 1st Red Angus Bull at ABS



Mrs. Waldo (Sal) Forbes was honored as the first woman inducted into the Saddle and Sirloin Club's portrait gallery in Louisville, KY.

Beckton Stock Farm

Cam and Sal Forbes
37 Beckton Drive
Sheridan, WY 82801

Tel.: 307.674.6095, 674.8162 (evening)

Fax: 307.672.7281

Email: beckton@wavecom.net

Web: www.BecktonRedAngus.com

FIRST CLASS

LOWEST FEED REQUIREMENT

Beckton is the #1 herd for Low Maintenance Energy requirements, with the lowest average Cow Maintenance EPD of any major herd. The average Beckton bull in this sale is in the top 5% of the Red Angus breed for low Maintenance Energy EPD.

RAPID GROWTH TO MARKET

Beckton bulls are leaders in total birth-to-market rate of growth. The average bull in this sale goes from -3.6 pounds at birth (BWE PD) to +58 pounds at yearling (YWE PD). This spread of +62 pounds exceeds most other Red Angus bulls.

EASIEST CALVING

Beckton is also the #1 herd for easy calving, with the best average Calving Ease EPD of any major herd. The average Beckton bull in this sale is in the top 5% of the entire Red Angus breed for calving ease.

DISPOSITION, FERTILITY, ALTITUDE ADAPTATION

More than 65 years of selection for functionality – good dispositions, high cowherd fertility, good udders and milk. Our cattle rotate between Wyoming range and high elevations in the Bighorn Mountains, so they offer excellent altitude adaptation and strong feet and legs.



Free Delivery
anywhere in the Continental US